

Panasonic®

High Definition Projection Television Operating Instructions

Televisor de Proyección de Alta Definición Instrucciones de Operación

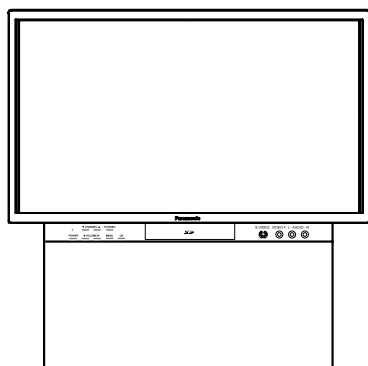

PT-47WXD63
PT-53WXD63

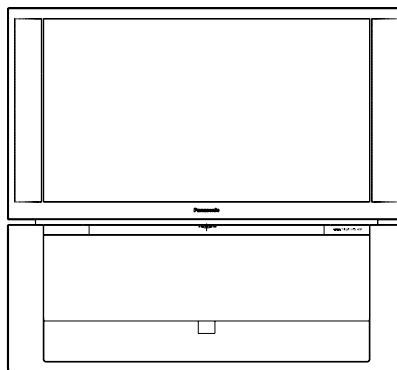



PT-53TWD63
PT-56TWD63

*The presence of the DTV certification mark indicates that this product will successfully receive digital television transmissions that conform to any and all of the video formats described in the ATSC Digital Television Standard.

TQB2AA0474
PRINTED IN USA
IMPRESO EN EE.UU.

30728

	<p>WARNING</p> <p>RISK OF ELECTRIC SHOCK DO NOT OPEN</p>		<p>The lightning flash with arrow head within a triangle is intended to tell the user that parts inside the product are a risk of electric shock to persons.</p>
<p>WARNING: To reduce the risk of electric shock do not remove cover or back. No user-serviceable parts inside. Refer servicing to qualified service personnel.</p>			<p>The exclamation point within a triangle is intended to tell the user that important operating and servicing instructions are in the papers with the appliance.</p>

WARNING: To reduce the risk of fire or electric shock, do not expose this apparatus to rain or moisture and objects filled with liquids, such as vases, should not be placed on this apparatus.

 The Class II insulation symbol (square within a square) indicates that this product has been evaluated and tested to comply with Class II insulation requirements.

FCC CAUTION: ANY CHANGES OR MODIFICATIONS TO THIS PTV RECEIVER NOT EXPRESSLY APPROVED BY MATSUSHITA ELECTRIC CORPORATION OF AMERICA COULD CAUSE HARMFUL INTERFERENCE, WHICH WOULD VOID THE USER'S AUTHORITY TO OPERATE THIS EQUIPMENT.

WARNING: AS WITH ANY SMALL OBJECT, SD CARDS CAN BE SWALLOWED BY YOUNG CHILDREN. DO NOT ALLOW CHILDREN TO HANDLE THE SD CARD.

ENVIRONMENTAL NOTICE: THIS PRODUCT UTILIZES CATHODE RAY TUBES (CRT) AND OTHER COMPONENTS THAT CONTAIN LEAD. DISPOSAL OF THESE MATERIALS MAY BE REGULATED IN YOUR COMMUNITY DUE TO ENVIRONMENTAL CONSIDERATIONS. FOR DISPOSAL OR RECYCLING INFORMATION PLEASE CONTACT YOUR LOCAL AUTHORITIES, OR THE ELECTRONICS INDUSTRIES ALLIANCE: <HTTP://WWW.EIAE.ORG.>

 **HDMI™** HIGH DEFINITION MULTIMEDIA INTERFACE HDMI, the HDMI logo and High Definition Multimedia Interface are trademarks or registered trademarks of HDMI Licensing LLC.

 **SD™**: SD Logo is a trademark.

 **VIM**
BBE® HD3D Sound
BBE®
High Definition Sound

Manufactured under license from BBE Sound, Inc.
Licensed by BBE Sound, Inc. under USP4638258, 4482866, 5510752 and 5736897. BBE and BBE symbol are registered trademarks of BBE Sound, Inc.

This product incorporates copyright protection technology that is protected by U.S. patents and other intellectual property rights. Use of this copyright protection technology must be authorized by Macrovision Corporation, and is intended for home and other limited viewing uses only unless otherwise authorized by Macrovision. Reverse engineering or disassembly is prohibited.

U.S. Patents Nos. 4,631,603; 4,577,216; 4,819,098; 4,907,093; 6,381,747; and 6,516,132.

Read these instructions completely before operating television.
Contents are subject to change without notice or obligation.

Copyright 2003 by Matsushita Electric Corporation of America. All rights reserved.
Unauthorized copying and distribution is a violation of law.

Important Information

Information Regarding Convergence

In the projection television, the image is formed by projecting 3 different color images (red, green and blue) onto the projection screen. **Convergence refers to the alignment of red, green and blue images on the projection screen.** When these images are properly aligned (converged), you see a sharp and vibrant color image. Sometimes, the three images may require alignment. This is due to the effect of earth's magnetic field on the projection tubes. Normally, adjustment is not necessary after the initial alignment at the center of the screen. It is possible to correct the color fringing on other areas of the screen by using the buttons on the remote control and by following the on-screen instructions in the set-up menu. Please converge the images before using the television for the first time. The following diagram shows examples of a misaligned image and a properly aligned image. **Please refer to pages 26 and 27 for detailed procedure on how to adjust convergence.**

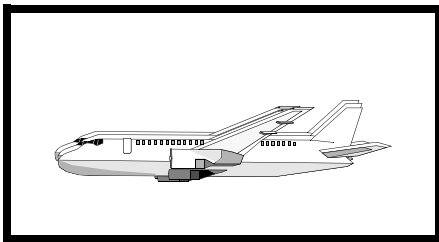

Misconverged image

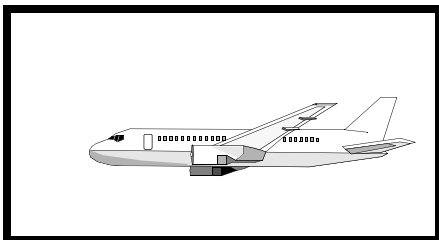

Properly aligned image

Notes:

- Make sure that the set is on for at least 20 minutes before adjusting convergence as described on pages 26 and 27.

Important Information Regarding The Use Of Video Games, Computers, Or Other Fixed Image Displays.

WARNING: The marking or retained image on the picture tube resulting from viewing fixed image is not an operating defect and as such is not covered by Warranty.

The projection television is designed to display constantly moving images on the screen. Continuous viewing of stationary images such as letterbox pictures on standard screen TVs (with top/bottom bars), non-expanded standard (4:3) pictures on wide screen TVs (with side bars shown on each side of an image), stock market report bars (ticker running at the bottom of the screen), video game patterns, fixed scoreboards, bright station logos, on-line (Internet) or repetitive computer style patterns should be limited.

The extended use of fixed image program material can cause a permanent picture tube damage, shown as a "shadow image" viewable on normal programs. This type of irreversible picture tube deterioration can be limited by performing the following steps:

- Limit the display of fixed image program material to no more than 15% of total viewing time per week.
- Turn the power off when not in use.

FCC INFORMATION

This equipment has been tested and found to comply with the limit for a Class B Digital Device in accordance with the specifications in Part 15 of the FCC Rules. The limits are designed to provide reasonable protection against radio and television interference in a residential installation. This equipment generates, uses and can radiate radio frequency energy and, if not installed and used in accordance with the instructions, may cause harmful interference to radio communications. However, there is no guarantee that interference will not occur in a particular installation.

If this equipment does cause interference to radio or television reception (which you can determine by turning the equipment off and on), try to correct the interference by one or more of the following measures.

- Reorient or relocate the receiving antenna.
- Increase the separation between the equipment and the receiver.
- Connect the equipment into an outlet on a circuit different from that to which the receiver is connected.
- Consult the dealer or an experienced radio/TV technician for help.

Table of Contents

Important Information 1

- Information Regarding Convergence..... 1
- Information Regarding The Use Of Video Games
Computers, Or Other Fixed Image Displays..... 1

Congratulations 3

- Customer Record..... 3
- Care and Cleaning..... 3
- Specifications..... 3
- Feature Chart..... 3

Installation..... 4

- Television Location 4
- Component Connection Cables..... 4
- AC Power Supply Cord..... 4
- Cable / Antenna Connection..... 4
- First Time Setup 4

**Front and Rear View of the High Definition
Projection Television..... 5**

Optional Equipment Connections..... 6

- VCR Connection 6
- Digital Cable Module Connection 6
- Digital TV - Set-Top Box (DTV-STB) or DVD Players 6
- Front Control Panel..... 6
- HDMI Input Connection 7
- Digital Audio Out connection 8
- Program Out Connection 8
- Amplifier Connection (Analog)..... 8

PIP Operation 9

- PIP Operation 9
- Split Operation 9

PIP And Split Operational Buttons..... 9

- TV/Video Button 9
- Search Button..... 9
- Move Button 9
- PIP MIN and PIP MAX Buttons 10
- Freeze Button..... 10
- Main Picture Freeze Feature..... 10
- PIP, Split and Freeze Mode Buttons
Operational Chart 10

**Special Feature of the High Definition
Projection Television 11**

Special Remote Buttons 12

Remote Control Operation 13

- Operating Components with Remote Control..... 14
- Programming the Remote 16
- Programming Without a Code 16
- Component Codes 16

Basic Menu Navigation..... 19

Menu Operations..... 20

- Picture 20
- Audio 20
- Channel..... 21
- Photo Viewer™ Operation..... 22
- Timer 24
- Set Up 25
- Lock..... 28

Glossary and Acronyms..... 31

Troubleshooting Chart 32

Index..... 34

Note: The warranty and service center information is located in the back of this manual.

Congratulations

Your new High Definition Projection Television (PTV) features state-of-the-art technology for high quality picture and sound with complete audio/video connections for your home theater system. Your PTV is designed to give you many years of enjoyment. It was thoroughly tested and tuned at the factory for best performance.

Customer Record

The model and serial number of this product are located on the back of the TV. You should note the model and serial number in the space provided and retain as a permanent record of your purchase. This will aid in identification in the event of theft or loss. Product registration for U.S. customers is available at: www.prodreg.com/panasonic.

Model

Number

Serial

Number

Care and Cleaning

Projection Screen (Turn PTV Off)

The projection screen is a high precision lens system which has a protective screen. The protective screen is fully washable with the following precautions:

- Use a mild soap solution or window cleaner and a clean cloth.
- DO NOT USE ABRASIVE CLEANERS.
- Do not use laundry detergent or automatic dishwasher soap.
- Do not use alcohol, ammonia, or petroleum based products.
- Avoid excessive moisture and wipe dry.
- Prevent solution from running into the receiver below.
- Avoid bumping or scraping the screen.

Note: Do not spray any type of cleaning fluid directly on the screen.

Cabinet and Remote Control

- For cabinets and remote control, use a soft cloth dampened with water or a mild detergent solution. Avoid excessive moisture and wipe dry.
- Do not use benzene, thinner or other petroleum based products.

Specifications

Specifications are subject to change without notice or obligation.

Power Source PT-47WXD63 (4.1A) PT-53WXD63 (4.1A) PT-53TWD63 (4.1A) PT-56TWD63 (4.1A)	120V AC, 60Hz
Channel Capability ATSC/NTSC	VHF/UHF- 2-69 CATV - 1-136
HDMI Input jack	Type A
Digital Audio Out jack	PCM / Dolby* Digital Fiber Optic
Component Inputs (Y / P_B / P_R)	75 Ohm, Phono Jack Type
Video Input Jacks	1Vp-p, 75 Ohm, Phono Jack Type
Audio Input Jacks	500mV RMS 47K Ohm
Video out jack	1Vp-p, 75 Ohm, Phono Jack Type
Audio Output Jacks	500mV RMS 4.7K Ohm
S-Video Input Jacks	S-Video (Y-C) Connector

Feature Chart

MODELS	PT-47WXD63	PT-53WXD63	PT-53TWD63	PT-56TWD63
FEATURES				
ATSC DIGITAL TUNER	•	•	•	•
PHOTO VIEWER™	•	•	•	•
DIGITAL CABLE MODULE (DCM)	•	•	•	•
2 TUNER PIP/SPLIT	•	•	•	•
2 RF	•	•	•	•
ZOOM ADJUST (SIZE AND POSITION)	•	•	•	•
PROTECTIVE SCREEN	•	•	•	•
CLOSED CAPTIONING	•	•	•	•
V-CHIP CAPABILITY	•	•	•	•
DIGITAL SCAN RATE	1080i, 540p	1080i, 540p	1080i, 540p	1080i, 540p
NTSC LINE-DOUBLER	540p	540p	540p	540p
VIDEO NORM	•	•	•	•
AUDIO NORM	•	•	•	•
STEREO	•	•	•	•
AI SOUND	•	•	•	•
BASS/BALANCE/TREBLE	•	•	•	•
SURROUND	•	•	•	•
BBE VIVA 3D			•	•
BBE	•	•	•	•
HDMI/HDCP INPUT	•	•	•	•
A/V IN (REAR/FRONT)	4 (3/1)	4 (3/1)	4 (3/1)	4 (3/1)
DIGITAL AUDIO OUT	•	•	•	•
S-VHS INPUTS	•	•	•	•
COMPONENT INPUTS	•	•	•	•

*Manufactured under license from Dolby Laboratories.

"Dolby" and the double-D symbols are trademarks of Dolby Laboratories.

Installation

Television Location

This unit can be used as part of an entertainment center. Consult your dealer for available options.

- Avoid excessive sunlight or bright lights, including reflections.
- Keep away from excessive heat or moisture. Inadequate ventilation may cause internal component failure.
- Fluorescent lighting may reduce remote control transmitting range.
- Keep away from magnetic equipment, including motors, fans and external speakers.

Component Connection Cables

Shielded audio and video cables should be used between components. For best results:

- Use 75-ohm coaxial shielded cables.
- Use appropriate input and output connectors, that match your component connectors.
- Avoid long cables to minimize interference.

AC Power Supply Cord

CAUTION: TO PREVENT ELECTRIC SHOCK, MATCH WIDE BLADE OF PLUG TO WIDE SLOT OF AC OUTLET AND FULLY INSERT. DO NOT USE A PLUG WITH A RECEPTACLE OR OTHER OUTLET UNLESS THE BLADE CAN BE FULLY INSERTED TO PREVENT BLADE EXPOSURE.

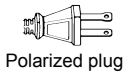

PROTECT POWER CORDS FROM BEING WALKED ON, ROLLED OVER, CRIMPED, BENT, OR PINCHED, PARTICULARLY AT PLUGS, CONVENIENCE RECEPTACLES, AND THE POINT WHERE THEY EXIT FROM THE APPARATUS.

Cable / Antenna Connection

For proper reception of analog or digital cable channels, a cable service connection is required.

Cable Connection

Connect the cable supplied by your local cable company to ANTENNA (A) connection on back of television. Select Cable mode and ANTENNA (A) in SET UP menu under Program CH (Program Channels).

Incoming Cable from Cable Company

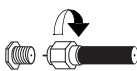

75 Ohm ANT A

Antenna Connection

- For proper reception of digital and analog VHF/UHF channels, an external antenna is required. For best reception an outdoor antenna is recommended.
- Connect home antenna to either ANT (A) or ANT (B) connection on back of the television. Select Antenna mode for ANTENNA (A) or (B) in Input Setup under Program CH in Setup menu.

Incoming Cable from Home Antenna

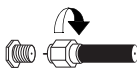

Note: Cable Mode is preset at the factory. Antenna users must change to ANTENNA Mode for ANTENNA (A) in the Set Up menu. If you have both Cable and Antenna, the Cable **must** be connected to ANT (A).

First Time Setup

For your convenience, First Time Set up menu will be displayed on screen when the set is turned on for the first time. If needed, follow the menus and procedures displayed on-screen for setting up the features.

Input Setup

To select the configuration of RF input depending on the signal source.

Note: No video will be displayed in this setup mode.

Procedure

- Press **VOL** ► to select Cable only, Cable/Antenna or Antenna only.
- Press the **OK** button to underline your selection.

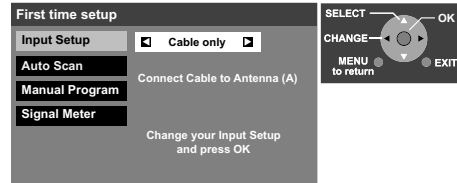

- When the next screen is displayed, press **OK** button to start the Auto Scan. All available channels with a signal will be programmed into memory.

Auto Scan

This feature allows you to selectively auto scan channels. You can Scan All, Analog only channels or Analog & Digital channels.

Procedure

- Press **OK** button to start Auto Scan.

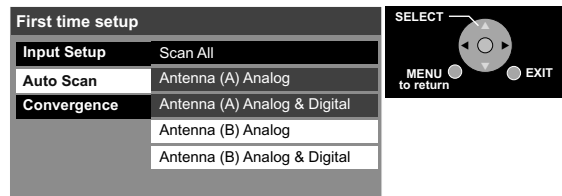

- After Auto Scan is completed the PTV tunes to the first channel found during auto scan.

Notes:

- If the EXIT button is pressed at anytime during auto scan, the First Time Setup menu will be cancelled and the PTV will tune to analog channel 2 on ANTENNA (A).
- If a DCM (Digital Cable Module) is present during the First Time Setup and Antenna (A) is set to cable, Antenna (A) will not be scanned due to the DCM providing the channel map.

Convergence

This menu lets you set the green CRT alignment and the center convergence. Follow the instructions on-screen to perform convergence. After convergence is performed, press **EXIT** to return to normal viewing.



Front and Rear View of the High Definition Projection Television

Front Panel (PT-47WXD63 and PT-53WXD63)

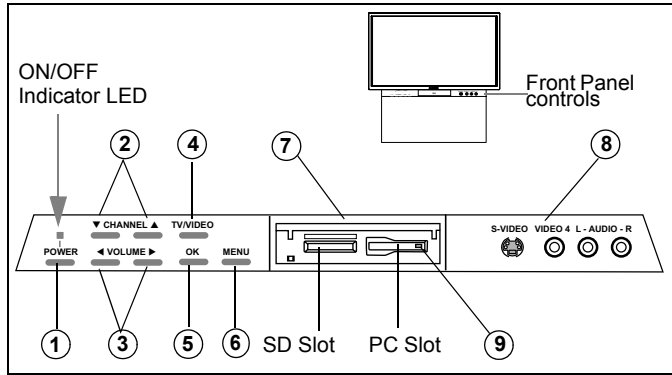

Front Panel (PT-53TWD63 and PT-56TWD63)

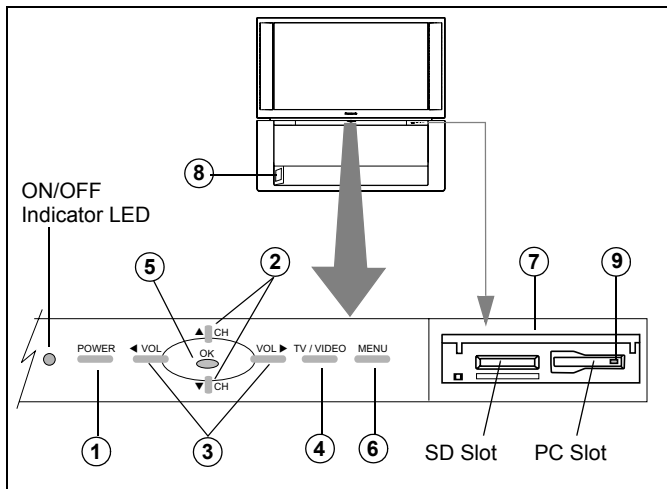

Feature	Description
① POWER	Toggles power OFF/ON
② ▼CH and CH▲	Tunes to lower or higher channels, navigate up/down in menus.
③ ◀VOL and VOL▶	Decrease or increase volume, navigate left/right in menu, adjust selected feature in menu.
④ TV/VIDEO	Changes Input source
⑤ OK	Completes channel specification, press to accepts menu and sub-menu selection.
⑥ MENU	Display or remove menu or return one step backward in menus.
⑦ Photo Viewer™	Lets you display JPEG images recorded on memory cards by a digital camera. The Photo Viewer™ is located behind the door marked SD.
⑧ Input 4	Analog inputs for external devices Note: Input 4 for PT-53TWD63 and PT-56TWD63 is located on the pillar on the bottom left side of the cabinet.
⑨ Eject button	Push this button to eject PC card.

Rear Panel Jacks

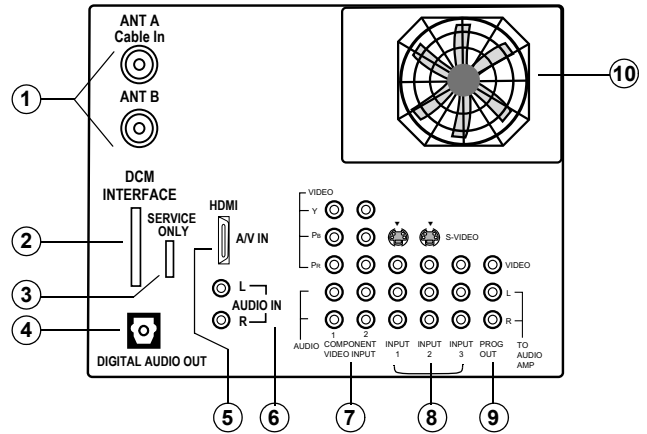

Item #	Description
①	Antenna Inputs ANT A - Connect Cable Antenna or Terrestrial Antenna to this input to receive Digital channels. ANT B - If you have both Cable antenna and Terrestrial antenna, connect the Terrestrial antenna to ANT B.
②	DCM INTERFACE (POD INTERFACE) Insert the DCM (Digital Cable Module) or POD (Point of Deployment) module from the Cable company to receive premium digital service.
③	SERVICE ONLY Card slot used by a certified service technician only. Do not insert any memory card into this slot.
④	DIGITAL AUDIO OUT 5.1 Dolby Digital surround sound optical output.
⑤	HDMI (High Definition Multimedia Interface) Input that accepts uncompressed digital signal and multi channel digital audio signal.
⑥	AUDIO IN Use these audio inputs when DVI devices are connected to HDMI input using the DVI to HDMI adaptor.
⑦	COPONENT VIDEO (Y-P_B-P_R) INPUTS Use these jacks for connecting devices such as a DVD player or Set Top Box.
⑧	INPUTS 1, 2 and 3 Composite inputs for connecting VCR and other devices.
⑨	PROG OUT Terminals that output fixed audio and NTSC composite video.
⑩	Cooling fan

*The indication on the back panel may change without notice.

Optional Equipment Connections

Note: The remote control must be programmed with supplied codes to operate the optional equipment.

VCR Connection

Follow this diagram when connecting your television to a VCR only.

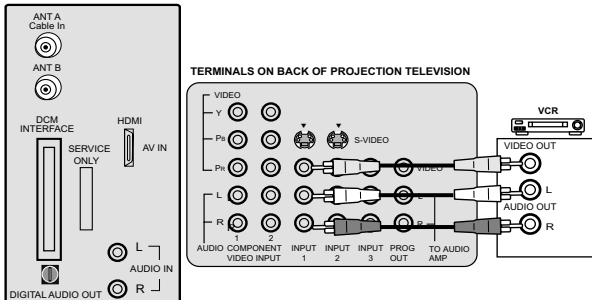

Procedure

- Press the **TV/VIDEO** button on the remote control to select the video input (VIDEO 1, VIDEO 2, etc.) connected to your VCR.
- Begin the video.

Digital Cable Module Connection

This module allows you to tune digital and high definition cable channels through the cable antenna. Consult your Cable company on the availability of this module (also called Point of Deployment (POD) module).

Note: A Digital Cable Subscription is required. (refer to pg. 27)

Procedure

- Connect the Cable antenna to **ANT A/Cable In** input on the back of the PTV.
- Insert the DCM (Digital Cable Module) (upper side facing left) into the DCM INTERFACE (POD INTERFACE) slot on the back of the PTV.

Notes:

- Left side is the upper side of the DCM cards.
- Do not insert a PCMCIA card into the DCM INTERFACE (POD INTERFACE).
- Choose Cable mode for Antenna (A) in Input Setup.
- Follow the instructions on screen.

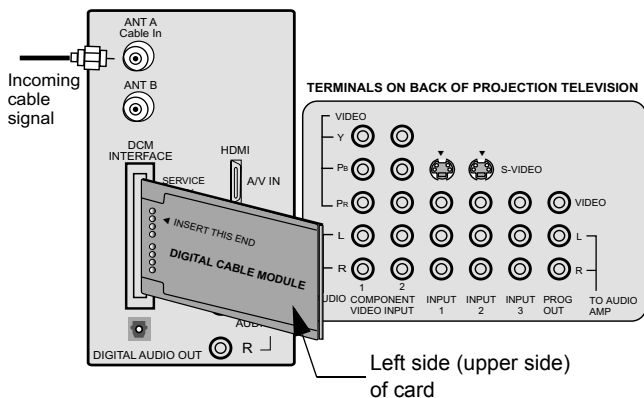

Note: If you experience keyboard or remote control function hang-up when using DCM (Digital Cable Module), unplug the PTV and plug it back on and try the controls again. If

this condition still exists, please call Panasonic Customer Call Center for further instructions.

Digital TV - Set-Top Box (DTV-STB) or DVD Connection

This television is capable of receiving 1080i, 480p, and 480i DTV signals when connected to a DTV tuner set-top-box (STB) or a DVD player. In order to view DTV programming, the STB must be connected to the component video inputs (Y,PB,PR) of the PTV. A DTV signal must be available in your area. Select the output of the STB to either 1080i or 480p.

This television also utilizes a progressive scan doubler, which de-interlaces the NTSC signal and progressively scans the image. This allows you to sit close to the TV and not see the thin black horizontal lines (venetian blind effect) associated with interlaced TV pictures.

Use this diagram to connect the DTV-STB or DVD player to the back of your projection television.

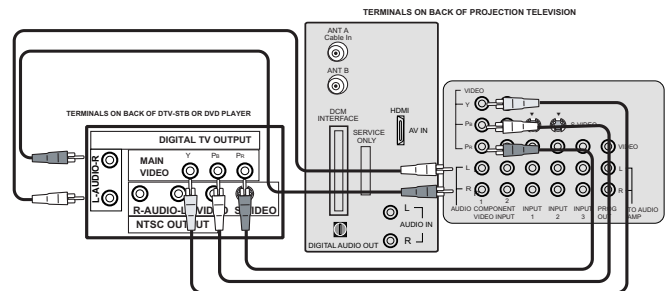

Note: There are two set of three video jacks, Y, P_B, and P_R. Separate component color inputs provide luminance and color separation. Use the L (left) and R (right) audio inputs.

Front Control Panel

The front control panel can be used to access menus and switch video mode when the remote control is not available.

The ON/OFF indicator LED (red) will be lit when set is on.

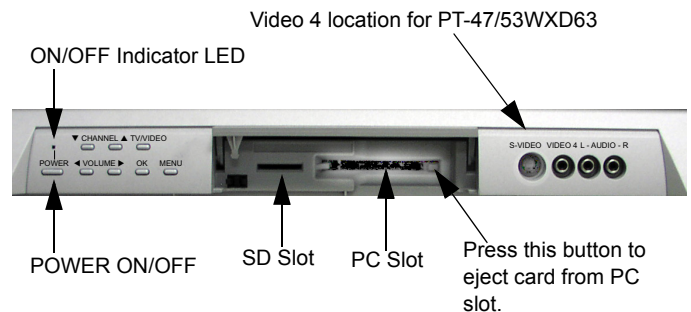

A second VCR, Camcorder, a video disc player, video game equipment or DSS equipment can also be connected to the video inputs. See the optional equipment manual for details.

Procedure

- Connect equipment to front Audio/Video input jacks.
- Press TV/VIDEO button to select VIDEO 4 input mode.
- Operate optional equipment as instructed in equipment manual.

HDMI (High Definition Multimedia Interface) input connection

About HDMI

HDMI is the first all digital consumer electronics A/V interface that supports several uncompressed standard, enhanced and high definition video format as well as existing multi-channel audio format. One jack supports both video and audio information. The HDMI/HDCP¹ input can be connected to an EIA/CEA 861² compliant consumer electronic device, such as a set top box or DVD player equipped with a HDMI or DVI output connection. By inputting a High-bandwidth Digital Content Protection (HDCP) high definition picture source to the HDMI terminal of this PTV, high definition pictures can be displayed on the screen in their digital form. The HDMI input terminal is not intended to be used with personal computers. This PTV is compatible with 1080i, 480p and 480i formats. Select the output of the connecting to device to match that of the PTV.

Notes:

1. HDMI/HDCP = High Definition Multimedia Interface / High-Bandwidth Digital Copy Protection.
2. EIA/CEA-861 Profiles compliance covers profiles for transmission of uncompressed digital video including high bandwidth digital content protection.

Compatible formats

This PTV is compatible with following formats. Please set the connecting device to following format.

Video signal

Format	No of dots	Vertical scanning frequency (Hz)
1080i	1920 x 1080i	59.94 / 60
540p (480p)	720 x 480p	59.94 / 60
	640 x 480p	59.94 / 60
540p (480i)	720 x 480i	59.94 / 60

Audio signal

When digital audio is included in the HDMI connection, the compatible sampling frequencies are 48 KHz / 44.1Khz / 32 KHz.

Connection diagram

Follow the diagram below to connect the PTV to a set top box or a DVD player.

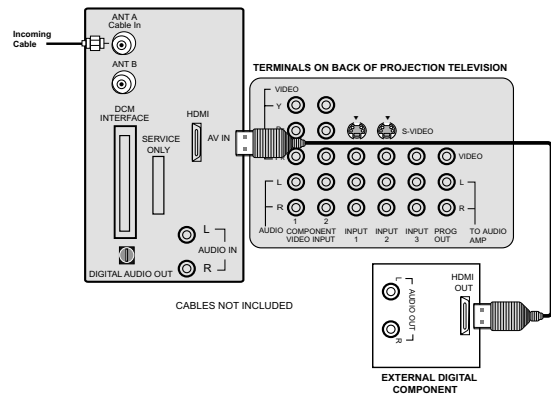

* The connector on the PTV is HDMI Type A connector.

Procedure

- Connect the HDMI output from the set top box or a DVD player to the HDMI input on the back of the PTV.
- Press TV/VIDEO button on the remote control to select HDMI input. The connector on the PTV is HDMI Type A connector.
- If the external device has DVI output only, use a DVI to HDMI adaptor cable*³ to connect to the HDMI jack on the PTV. Also, connect the Audio Out signal from the external device (set top box or DVD player) to the Audio In*⁴ jacks below the HDMI input.
- If you cannot display the picture because of your Digital Set Top Box does not have a Digital Out terminal setting, use the Component Video Input (or the S-Video Input or Video Input). In this case, the picture will be displayed as an analog signal.

Notes:

- *3. HDMI-DVI conversion cable (TY-SCH03DH) available on Panasonic Website: www.panasonic.com.
- *4. Please refer to pages 20 and 21 for Audio setting detail.

Digital Audio Out Connection

Use the diagram below to connect the Digital Audio Output of your HDTV Projection Television to a Dolby Digital decoder.

Digital Audio Out

Dolby Digital 5.1 channel surround sound delivers digital-quality sound. Dolby Digital provides five discrete full-bandwidth channels for front left, front right, center, surround left and surround right, plus a LFE (Low Frequency Effect) subwoofer channel. For a full Home Theater sound experience, an external Dolby Digital decoder and a multichannel amplifier must be connected to the Digital Audio Out jack on the PTV.

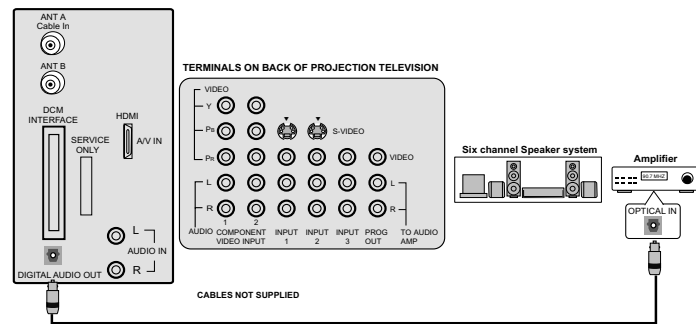

Procedure

- Connect the Digital Audio cable from the Digital Audio Out jack on the PTV to the Digital Audio In connection on the Dolby Digital decoder.

Note: When ATSC channel is selected, the output from the Digital Audio Out jack will be Dolby Digital. But, if NTSC channel is selected, the output will be PCM.

Program Out Connection (PROG OUT)

You can connect a VCR to the PROG OUT terminal to record the program you are viewing on-screen. An external monitor can also be connected to the PROG OUT and TO AUDIO AMP terminals. Connect the VCR as shown below.

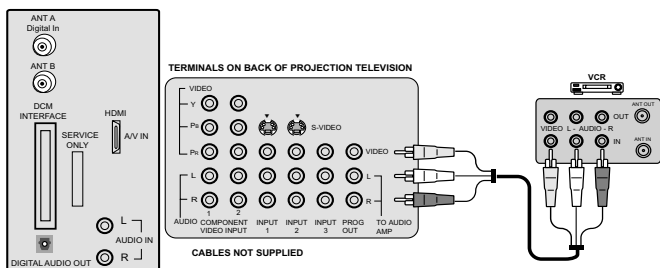

Procedure

- Connect the VCR to PROG OUT and TO AUDIO AMP terminals
- PROG OUT terminal display is the same as on-screen display.
- See the VCR instruction manual for further instructions for recording the program.

Notes:

- This TV contains Video and Audio Outputs for the purpose of recording television programming to VCR. Due to license restrictions, if a device (STB, DVD, etc.) is

connected to the HDMI input of the TV, no video or audio output is allowed.

- Program Out signal may not be available when component input is selected for main picture.
- Program Out signal is available when receiving digital channel. However, all digital formats are down converted to composite NTSC video.
- When receiving digital or analog channels signals and the analog or digital CC is ON, Program Out connector will output open caption text in the NTSC video picture. If CC is OFF, only analog CC closed caption code is passed out the Program Out connector.
- Certain program content output from the Program Out connector may have the Macrovision signal modification applied to its signal, preventing VCRs from recording this video signal.

Amplifier Connection (Analog)

To listen the audio through a separate stereo system, connect an external audio amplifier TO AUDIO AMP outputs on back of television.

Note: TO AUDIO AMP terminals cannot be connected directly to external speakers.

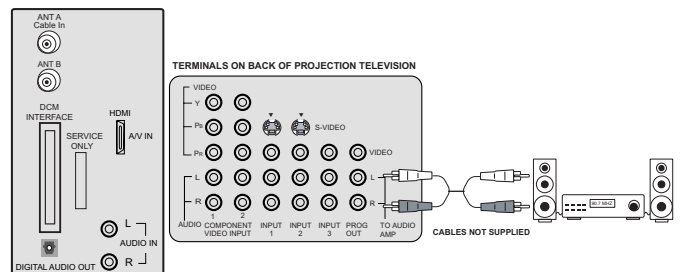

Audio Adjustments

- Select Speakers Off in Audio Other Adjust menu.
- Set amplifier volume to the preferred level.

PIP Operation

This television includes a two-tuner Picture In Picture (PIP) feature. This allows you to watch two (2) live broadcasts at the same time with or without an external video source such as a VCR, cable box, etc.

Note: Only the Analog programming from Antenna (A) and video inputs signal can be viewed in the PIP/SPLIT frame.

Procedure

- Connect incoming cable to ANT (A) input on back of TV.
- Press **PIP** to display PIP frame.
- Select channels for the PIP frame by pressing **PIP CH** **DVD/VCR CH** .
- Select channels for the Main picture by pressing or **CH** or use the remote control numeric keypad.
- Press **SWAP** to switch the PIP and MAIN PICTURE source.
- Press to view picture source status.
- Press **PIP** to cancel PIP frame.

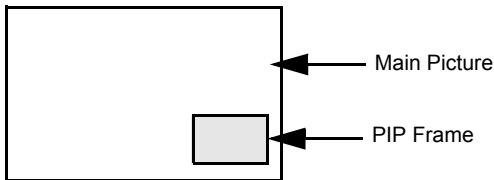

Note: Audio is from Main Picture only.

Split Operation

This feature lets you watch two different channels side by side with or without an external video source.

Procedure

- Press **SPLIT** to display Split screen.
- Select channels for the Split by pressing **PIP CH** **DVD/VCR CH** .
- Select channels for the Main picture by pressing or **CH** or use the remote control numeric keypad.
- Press **SWAP** to switch the SPLIT SCREEN and MAIN PICTURE source.
- Press to view picture source status.
- Press **SPLIT** to cancel Split screen.

Note: PIP or SPLIT frame cannot display digital channel signal. You can display digital channel as the Main picture and analog

channel in PIP/SPLIT frame or analog channels in both Main and PIP/SPLIT frame. Swap is possible when both Main picture and PIP/SPLIT picture are analog channels or video input sources.

PIP and Split Operational Buttons

TV/VIDEO Button

Press when PIP or Split frame is displayed to select desired input mode.

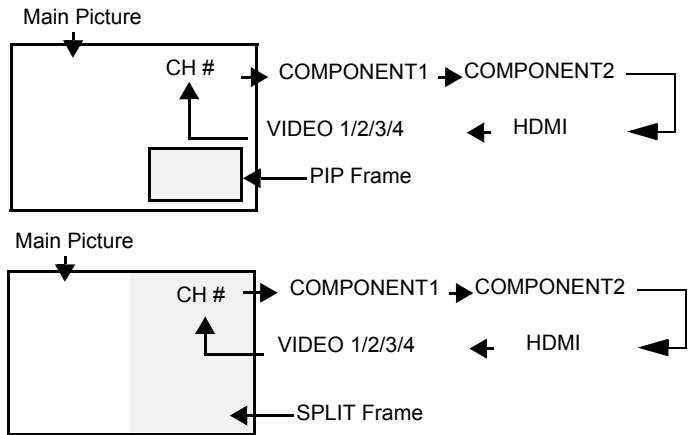

Search Button (PIP and Split)

This feature lets you scan through all available analog channels.

Procedure

- Press **PIP** or **SPLIT** to display PIP or Split frame.

SEARCH OPEN/CLOSE

- Press to display search frames.

Note: When the main picture is ATSC (terrestrial) digital channel, the search feature is unavailable. Search feature is available only for analog channels.

SEARCH OPEN/CLOSE

- Press again to stop search feature. PIP or Split frame channel will be the last active search frame.
- Press **PIP** or **SPLIT** to cancel PIP or Split frame

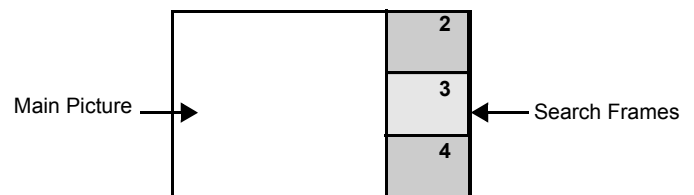

Move Button (PIP only)

This feature is used to move PIP frame to one of four corners.

Procedure

- Press **PIP** to display PIP frame.
- Press **MOVE** to position PIP frame to desired corner.
- Press **PIP** to cancel PIP frame.

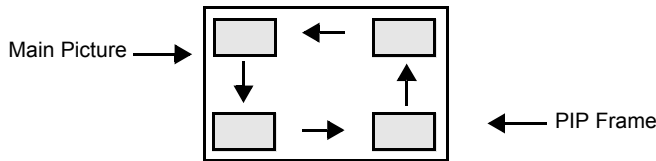

PIP MIN and PIP MAX Buttons

While PIP frame is displayed, press PIP MIN or PIP MAX button to vary the size of PIP frame.

Procedure

- Press **PIP** to display PIP frame.
- Press **PIP MIN** or **PIP MAX** to size PIP frame.
- Press **PIP** to cancel PIP frame.

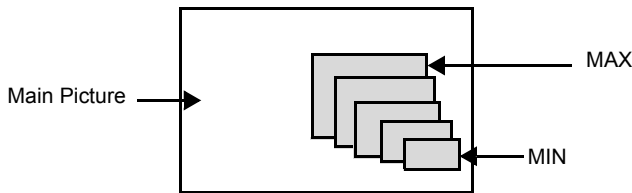

Freeze Button (PIP and Split)

This feature is used to stop action in PIP or Split frame.

Procedure

- Press **PIP** or **SPLIT** to display PIP or Split frame
- Press **FREEZE TV/VCR** to stop PIP or Split frame action.
- Press **FREEZE TV/VCR** again to continue action.
- Press **PIP** or **SPLIT** to cancel PIP frame.

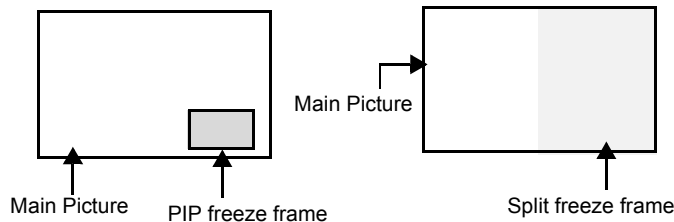

Note: Audio is from Main Picture only.

Main Picture Freeze Feature

This feature is used to stop action of the Main Picture and display it on a Split or PIP freeze frame.

Procedure

- To stop action for Main picture, press **FREEZE TV/VCR** while PIP or Split frame is not displayed.
- Main Picture freeze will be displayed in a PIP or Split frame, depending on the selection in the Freeze menu located in Picture Other ADJ. section (refer to page 20).
- Press **FREEZE TV/VCR** again to cancel Main Picture freeze frame.

Note: While Main Picture freeze frame is displayed, only MOVE button is active for PIP, all other PIP and Split buttons have no effect (see chart).

PIP, Split and Freeze Mode Buttons Operational chart

This chart indicates the buttons that are operational with PIP, Split or Main Picture Freeze mode.

REMOTE BUTTONS	PIP MODE	SPLIT MODE	MAIN PICTURE FREEZE MODE
PIP MIN	Size Smaller	No Effect	No Effect
PIP MAX	Size Larger	No Effect	No Effect
FREEZE	Freeze PIP frame	Freeze Split Frame	Display or Delete
PIP CH	Change Channel	Change Channel	No Effect
SEARCH	Displays Search Frame (not available when Main picture is digital)	Displays Search frame (not available when Main picture is digital)	No Effect
PIP	Delete PIP Frame	Displays PIP frame	No Effect
SPLIT	Displays Split Frame	Delete Split frame	No Effect
MOVE	Move PIP Frame	No Effect	Move PIP Frame
SWAP	Swap with Main Picture (not available when main picture is digital channel)	Swap with Main Picture (not available when main picture is digital channel)	No Effect

Special Features of the High Definition Projection Television

Channel and Program Tuning

Channel and Program tuning in digital television is different from current conventional television. In DTV, up to six (6) multiple programs can exist within a single 6MHz channel. These channels behave as sub-channels within a single channel. When tuning to a digital channel, the HDTV Projection Television will also tune to a program. The HDTV Projection Television will indicate the channel and program using the on-screen Channel Banner display.

Note: In order to select channels properly, Auto Scan must be performed (refer to page 25).

Tuning digital and analog channels

You can tune the digital and analog channels in the following ways:

- ❑ Direct tuning (0 - 9 keys) - using the numeric keys on the Remote control to directly input the Channel number. If necessary, use the \ominus button to enter the program number of the digital channel.
- ❑ Channel Up/Down Tuning (CH \blacktriangle or CH \blacktriangledown buttons) - Tunes to the next or previous available channel or program. The Channel Up/Down tuning depends upon the surfing mode (see pg. 21) you have set in the Channel menu.
- ❑ Rapid Tuning (**R-TUNE**) - Switches between the last two channels or programs.

Direct Tuning Method

Follow the procedure below to directly enter the channel number using the Remote Control numeric keys.

Procedure

- Press the numeric keys on the Remote Control to enter the Channel number. Press **OK** button.
- If tuning a digital channel and your channel contains more than one program, press the \ominus button and enter the program # (1, 2, 3 etc.) using the numeric keys. Press **OK** button. The following is an example of tuning to channel 15-1.

Direct Tuning Example

Step	Action	Channel Banner Display
1	Press 1	1
2	Press 5	15
3	Press \ominus	15-
4	Press 1	15-1
5	Press OK	15-1

The HDTV Projection Television will tune to channel 15-1.

Channel Banner: Minimized

The minimized Channel Banner will display the antenna input, channel number, and the station identification (if available).

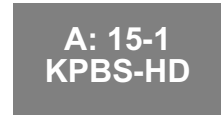

Channel Banner: Maximized

Press the **RECALL** button to display the maximized channel banner. While the channel banner is displayed, you can add the channel to Favorite channel list or delete the channel from the Favorite channel list.

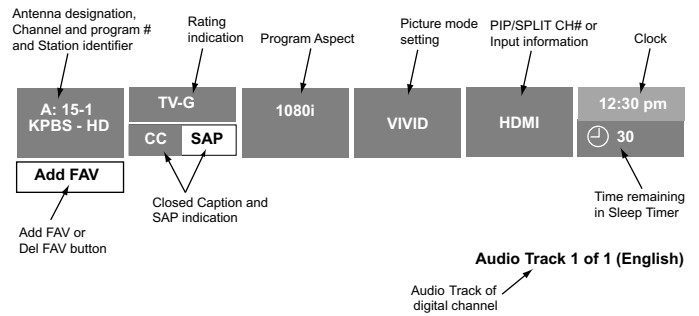

Add Fav / Del Fav feature

This feature lets you add channels to Favorite channel list or delete channels from Favorite channel list.

Procedure

- Tune the desired the channel to be added or deleted.
- Press the **RECALL** button to display the Channel Banner.
- Press the **OK** button to execute your choice.

Emergency Alert System (EAS) Forced Tuning

If a DCM (Digital Cable Module) is installed, the cable MSO (multiple system owner/operator) may provide an Emergency Alert System message. These messages are intended to alert the general public of important local or national emergency situations. In the event of receipt of one of these messages, the HDTV Projection Television shall immediately tune to the channel as directed by the EAS message. If the channel has blocked using the parental control, the parental blocking has priority over the forced tune.

Special Remote Buttons

ASPECT Button

Customer Options depending on Input Signal Format

INPUT SIGNAL	DISPLAY ON SCREEN	ASPECT BUTTON OPTIONS
1080i	16:9 only	No options
480p (16:9)	Default to 16:9	4:3, Full or Zoom (see below)
480p (4:3)	Default to FULL mode.	4:3, Full or Zoom (see below)
480i	Default to JUST mode	4:3, Full, Just or Zoom (see below)

The **ASPECT** button on the remote control lets you choose one of four display modes, depending on the formats of the received signal and your preferences.

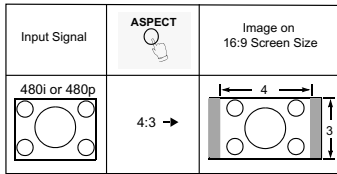

This will display a 4:3 picture at its standard 4:3 size with gray side bars. (Not recommended for viewing 4:3 pictures as it may create a permanent image on screen if displayed for a prolonged period of time.)

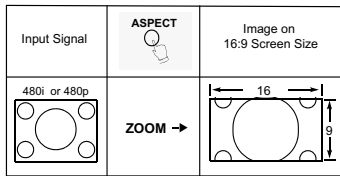

This will expand the 4:3 picture uniformly (width and height) to full screen width and then reposition the picture vertically. (Recommended for letterbox pictures.)

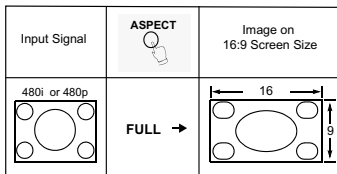

This will show picture at full screen size. (Recommended for anamorphic pictures.)

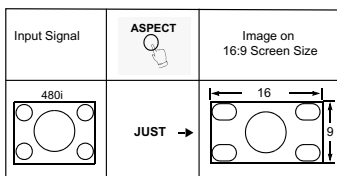

This will stretch the right and left edges of a 4:3 picture to fill the screen, The center of the screen will have aspect correction applied. The size of the picture will depend on the original signal. (Recommended for regular TV viewing.)

BBE Button

Press this button to turn BBE VIVA 3D (available on PT-53TWD63 and PT-56TWD63 only) or BBE sound feature (available on PT-47WXD63 and PT-53WXD63) **On** or **Off**.

SAP Button

Press this button to select the next audio track (if available) when receiving a digital channel.

Audio Track 1 of 1 (English)

In analog mode, press this button to cycle through different audio modes. For example:

- If receiving STEREO, SAP and MONO or receiving STEREO and MONO only, pressing SAP button, the audio will toggle as follows:

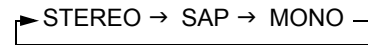

PROG button

When tuning digital channel, press the **PROG** button to enter the minor number in a compound channel number.

MENU button

Press to display the Main menu or return one step backward in menus.

RECALL button

Press this button to display or remove the channel banner.

R-TUNE Button

Press to switch to previously viewed channel, Photo Viewer™ or input modes.

Remote Control Operation

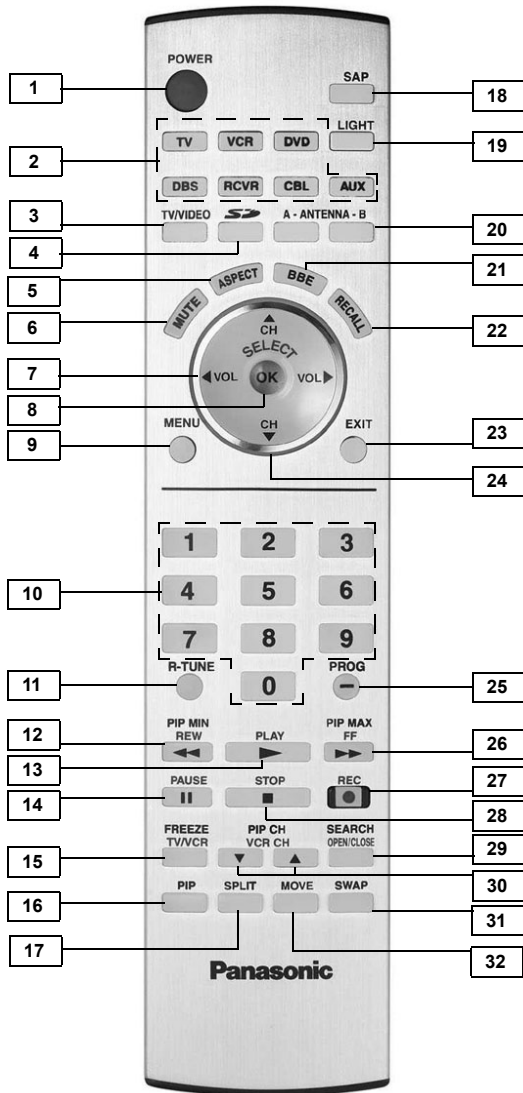

BUTTON NUMBER	DESCRIPTION
1	Press to turn ON and OFF. <i>Note: The ON/OFF indicator LED (red) will be lit when set is on.</i>
2	Press to select remote operation.
3	Press to select (Component 1 or 2), (HDMI), (Video 1, 2, 3 or 4) input mode or TV mode.
4	Press to access Photo Viewer™. Also press while Photo Viewer™ is displayed to access Photo Viewer™ set up menu.
5	Press to select picture size (ratio) to match programming format. Also used for Photo Viewer™ to change aspect of the image on-screen.
6	Press to mute sound. Press to display and cancel CC (Closed Caption).
7	Press to adjust TV sound and navigate in menus.
8	Press to choose menu and sub-menu entry.

BUTTON NUMBER	DESCRIPTION
9	Press to display Main Menu or return one step backward in menus.
10	Press numeric keypad to select any channel or press to enter alphanumeric input in menus.
11	Press to switch to previously viewed channel, Photo Viewer™ or input modes.
12	PIP MIN - While remote is in TV mode, press to decrease the PIP size. REW - While remote is in VCR or DVD mode, press to rewind.
13	While remote is in VCR or DVD mode, press to play.
14	While remote is in VCR or DVD mode, press to pause.
15	FREEZE - While in TV mode, press to stop action in the PIP or Split frame. TV/VCR - Press to switch to TV or VCR.
16	Press to display or delete PIP frame.
17	Press to display or delete Split frame.
18	In analog mode, press to access audio modes (Stereo, SAP or Mono). In digital mode, press to access next audio track.
19	Press to illuminate remote buttons.
20	Press to switch to (A or B) RF antenna input.
21	Press to turn BBE OFF or ON.
22	Press to display or delete Channel banner.
23	Press to exit menus.
24	Press to change channels and navigate in menus.
25	Press after entering major channel numbers to enter minor (-) channel numbers.
26	PIP MAX - While in TV mode, press to increase the PIP size. FF - While in VCR or DVD mode, press to fast forward.
27	While remote is in VCR mode, press to record.
28	While remote is in VCR or DVD mode, press to stop.
29	SEARCH - Press to scan available channels in search frames. Press again to delete search frames. OPEN/CLOSE - Press to open or close DVD tray.
30	Press to change channels for PIP or VCR.
31	Press to swap Main picture with PIP or Split frame.
32	While PIP frame is displayed, press to move to one of four corners.

Battery Installation

Use two AA batteries (supplied):

Remove battery cover by pushing the tab while lifting the cover up. Install batteries matching (+) and (-) polarity signs. Replace the battery cover.

Note: Incorrect installation can cause battery leakage and corrosion that will damage the Remote Control.

Precautions

Replace batteries in pairs. Do not mix battery types (zinc carbon with alkaline). Do not recharge, heat, short circuit, disassemble, or burn batteries.









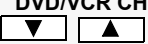

REMOTE CONTROL OPERATION

Operating Components with Remote Control

Note: Refer to page 16 for programming Remote Control procedure.



Operating a VCR

Program the remote control to use with VCR.

TO DO THIS...	PRESS
Turn on/off	POWER 
Select TV Input mode for VCR	TV/VIDEO 
Change Channels up/down	PIP CH DVD/VCR CH 
Record	REC 
Play	PLAY 
Stop	STOP 
Fast Forward	PIP MAX FF 
Rewind the Tape	PIP MIN REW 
Pause	PAUSE 
Change to TV or VCR Mode	FREEZE TV/VCR 
On screen VCR Display	RECALL 







Operating a CABLE BOX

Program the remote control to use with Cable Box.

TO DO THIS...	PRESS
Turn on/off	POWER 
Select a Channel	1 2 3 4 5 6 7 8 9 0
Change Channels Up/Down	▲ CH CH ▼
Back to previous channel	R-TUNE 









Operating a DBS

Program the remote control to use with DBS.

TO DO THIS...	PRESS
Turn on/off	POWER 
Display DBS menu	OK 
Menu Navigation	▲ CH VOL ◀ CH ▶ VOL ▼
Select a Channel	1 2 3 4 5 6 7 8 9 0
Program Information	RECALL 
Back to previous channel	R-TUNE 
Select next page up/down	PIP CH DVD/VCR CH 
Exit menus	EXIT 

Operating a DVD

Program the remote control to use with DVD

TO DO THIS...	PRESS
Turn on/off	POWER 
Next/Previous Chapter	▲ CH CH ▼
DVD Display	RECALL 
Skip Search Reverse	PIP MIN REW 
Skip Search Fast Forward	PIP MAX FF 
Play	PLAY 
DVD Open/Close	SEARCH OPEN/CLOSE 
Stop	STOP 
Still	PAUSE 
Slow +/-	FREEZE TV/VCR 

Operating a Cassette Deck

To operate a cassette deck, the remote control must be in AUX mode and be programmed with the appropriate code for your equipment.

TO DO THIS...	PRESS
Turn on/off	POWER
Receiver Volume Up/Down	VOL
Deck A/B	R-TUNE
Record	REC
Play	PLAY
Stop	STOP
Fast Forward	PIP MAX FF
Rewind the Tape	PIP MIN REW
Pause	PAUSE

Operating a Receiver

Program the remote to operate audio receiver.

TO DO THIS...	PRESS
Turn on/off	POWER
Audio Mute	MUTE
RCVR. VOI Up Down	VOL
Tuner Pre-set stations Up/Down	CH CH
To select AV Inputs or Components:	Press Remote numeric Keypad AV 1 Press 1 AV 2 Press 2 AV 3 Press 3 AV 4 Press 4 CD Press 5 TUNER Press 6 PHONO Press 7 TAPE Press 8 AUX Press 9
Surround VOL Down	PIP MIN REW
Surround VOL UP	PIP MAX FF
Center CH VOL Up/Down	PIP CH DVD/VCR CH

Operating a PVR (Personal Video Recorder)

Program the remote control to use with a PVR.

TO DO THIS...	PRESS
Turn on/off	POWER
Display PVR menu	MENU
PVR Navigation	CH VOL VOL CH
Select a Channel	1 2 3 4 5 6 7 8 9 0
Play	PLAY
Record	REC
Pause	PAUSE
Back to previous channel	R-TUNE
Exit menus	EXIT
Replay Zones	R-TUNE
Quick Skip	SEARCH OPEN/CLOSE
Return to live	PROG
PVR CH Up/Down	PIP CH DVD/VCR CH

Programming The Remote

The Universal Remote Control can be programmed to operate many manufacturers' components, using the component function buttons for VCR, DVD, DBS, RCVR or AUX. Follow the procedures for programming your Remote Control with or without a code for the component.

Device	Operates	Default
TV	TV (Panasonic Only)	Panasonic Code
VCR	VCR (Preset)	Panasonic Code
DVD/CD	DVD and CD (Preset)	Panasonic Code
DBS	DBS STB & CBL STB (Preset)	Panasonic DBS Code
RCVR	Audio Receiver (Preset)	Panasonic RCVR Code
CBL	Cable (Preset)	Panasonic CABLE Code
AUX	Personal Video Recorders, Cassette and VCR2	Panasonic Personal Video Recorder Code

Note: Determine the manufacturer of the component and look in the table for the code.

Procedure

- Confirm that the external component is plugged and operating.
- Turn the component off.
- Press **OK** and **POWER** together, for at least 5 seconds.
- Press appropriate component button on the Remote Control VCR, DVD, DBS, RCVR, CBL or AUX (PVR or VCR2)
- Enter the 3-digit component code using the Remote Control numeric keypad (0 ~ 9 buttons).
- Press the Remote Control **POWER** to test the component. If the procedure was successful, the component will turn on.

Note: If the component does not operate with the Remote Control, repeat the procedure using another code. (Some brands have multiple codes). If an incorrect code is entered, or if the procedure takes longer than 30 seconds, the programming will fail.

Programming Without A Code

This procedure searches all codes and is called the "sequence method."

- Confirm that the external component is plugged in and on.
- Turn the component off.
- Press **OK** and **POWER** together, for at least 5 seconds.
- Press appropriate component button on the Remote Control.
- Press **VOL** ► to move forward to the next code. Press **VOL** ◀ to move backward.

- Press the Remote Control **POWER** to test the component. If the procedure was successful, the component will turn on.

Note: Repeat the above steps until the component code is found. It may take many attempts before the correct code is found.

- After the code is found, press **OK** to store the code.

Component Codes

The Universal Remote Control is capable of operating many component brands after entering a code. Some components may not operate because the codes are not available due to limited memory. The Universal Remote Control does not control all features found in each model.

Write the code numbers from tables in this space. This will serve as a reference if you need to program your Remote Control.

VCR [][][]	DVD [][][]	DVD (CD) [][][]
DBS [][][]	RECEIVER [][][]	CABLE [][][]
AUX (PVR) [][][]	AUX (VCR2) [][][]	

Component Codes (cont.)

Codes For VCR	
Brand	Code
Admiral	335
Aiwa	332
Akai	314, 315, 316, 329
Audio Dynamic	311, 339
Bell & Howell	305, 313
Broksonic	320, 326
Canon	323, 325
CCE	343
Citizen	306
Craig	305, 306, 329
Curtis Mathes	324, 345
Daewoo	301, 324, 343
DBX	310, 311, 339
Dimensia	345
Emerson	303, 319, 320, 325, 326, 343
Fisher	305, 307, 308, 309, 313
Funai	320, 326, 334
GE	324, 333, 345
Goldstar	306
Gradiente	334
Hitachi	300, 323, 345
Instant Replay	323, 324
Jensen	339
JVC	310, 311, 334, 339
Kenwood	306, 310, 311, 339
LXI	300, 305, 306, 307, 308, 309
Magnavox	323, 324, 331
Marantz	310, 311, 339
Marta	306
Memorex	309, 324
MGA	338, 340, 341, 347, 348
Minolta	300, 345
Mitsubishi	338, 340, 341, 347, 348
Multitech	304, 347
NEC	310, 311, 334, 339
Olympic	323, 324
Optimus	306, 321, 328, 335
Orion	320, 326
Panasonic	321, 322, 323, 324
Penney	300, 305, 310, 311, 324, 339, 345
Pentax	300, 311, 345

Codes For VCR (Contd.)	
Brand	Code
Philco	320, 323, 324, 326, 331, 343
Philips	323, 324, 331
Pioneer	323
Proscan	300, 301, 302, 323, 324, 331, 333, 345, 346
Quasar	321, 322, 323, 324
Radio Shack	305, 309, 324, 333, 336, 340
RCA	300, 301, 302, 323, 324, 331, 333, 345, 346
Realistic	305, 309, 324, 336, 340
Samsung	302, 304, 333
Sansui	320, 326, 339, 352
Sanyo	305, 309, 313
Scott	301, 302, 304, 309, 320, 326, 338, 340, 347, 348
Sears	300, 305, 306, 307, 308
Sharp	335, 336
Shintom	317
Signature 2000	335
Singer	337
Sony	328, 329, 330
Sylvania	323, 324, 331
Tashiro	306
Tatung	310, 311, 339
Teac	310, 311, 339
Technics	321, 322, 323, 324
Teknika	324
Toshiba	301, 346
Vector Research	311
Wards	306, 309, 335, 336, 344
Yamaha	305, 310, 311, 339
Zenith	306, 344

Codes For Cable Box	
Brand	Code
ABC	124
Archer	125, 132
Cableview	105, 132
Citizen	105, 122
Curtis	112, 113
Diamond	124, 125, 132
Eagle	129
Eastern	134
GCbrand	105, 132
Gemini	122
General Instrument/ Jerrold	111, 119, 120, 121, 122, 124, 125, 126, 127
Hamlin	112, 118, 140, 141, 142, 145
Hitachi	103, 124
Macom	103, 104, 105
Magnavox	133
Memorex	130
Movietime	105, 132
Oak	102, 137, 139
Panasonic	109, 110, 114
Philips	106, 107, 128, 129, 130
Pioneer	101, 116
Pulsar	105, 132
Puser	132
RCA	115
Realistic	132
Regal	112, 118, 140, 141, 142, 145, 149
Regency	134
Rembrandt	105, 132, 137
Samsung	105
Scientific Atlanta	111, 112, 113
Slmark	101, 105
Sprucer	105, 110
Stargate	105, 110
Televue	101, 105
Texscan	144
Tocom	135
Toshiba	104
Unika	125, 232

Codes For Cable Box (Contd.)	
Brand	Code
Universal	122, 132
Videoway	106
Viewstar	129, 130
Zenith	100, 117
Zenith/Drake Satellite	100
Codes For DBS	
Brand	Code
Dish Network (Echostar)	105, 115, 116
Echostar	105
Express VU	105, 115
G. E.	106
G.I. (General Instrument)	108
Gradiente	114
Hitachi	103, 111, 112
HNS (Hughes)	103
Magnavox	101, 102
Panasonic	104
Philips	101, 102
Primestar	108
Proscan	106, 109, 110, 113
RCA	106, 109, 110, 113
Sony	107
Star Choice	103, 108
Toshiba	100
Uniden	101, 102
Codes For DVD	
Brand	Code
Denon	100
Ferguson	101
JVC	109
Mitsubishi	105
Nordmende	101
Panasonic	100
Philips	103
Pioneer	102
RCA	101
Saba	101
Samsung	110
Sharp	108
Sony	104
Technics	100
Thomson	101
Toshiba	103
Yamaha	100
Zenith	107

Component Codes (Cont.)

ENGLISH

Codes For Cassette Decks	
Brand	Code
Aiwa	223, 224, 225
Denon	231
Fisher	203
Jensen	214
JVC	229, 230
Kenwood	200, 207
Marantz	202
Nakamichi	205
Onkyo	208, 209, 213
Panasonic	216, 218
Philips	222
Pioneer	204
RCA	226, 227, 228
Sansui	205, 210
Sharp	231
Sony	219, 220
Teac	210, 211, 215
Technics	216, 218
Yamaha	201, 202

Codes For Receivers	
Brand	Code
Admiral	120
Aiwa	125, 126
Denon	134, 135, 136
Fisher	104
Garrard	113
Harman Kardon	115, 123
Jensen	129

Codes For Receivers (cont.)	
Brand	Code
JVC	132, 133
Kenwood	100, 108
Magnavox	127
Marantz	124
McIntosh	116
Nakamichi	106
Onkyo	109, 114
Optimus	103, 127, 130, 131
Panasonic	118, 119, 121
Philips	123
Pioneer	105, 107
Quasar	118, 119, 121
RCA	103, 105, 127, 130, 131
Sansui	103, 111, 139
Sharp	134, 137
Sony	122
Soundesign	138
Teac	111, 112, 113
Technics	118, 119, 121
Victor	132, 133
Yamaha	101, 102

Codes For CD Player	
Brand	Code
Admiral	226
Aiwa	233, 235
Carver	229
Denon	242
Emerson	239
Fisher	205
Harman/Kardon	219, 220, 221, 223
Hitachi	207
Jensen	234
JVC	240, 241, 245
Kardon	223
Kenwood	200, 201, 211, 245
LXI/Sears	236
Magnavox	229, 232
Marantz	229
McIntosh	221
Nakamichi	210
Onkyo	214, 215
Optimus	208, 218, 220, 222
Panasonic	224, 225, 227
Philips	229, 230
Pioneer	208
Quasar	224, 225, 227
RCA	231, 237, 238, 247
Sansui	210, 246
Sanyo	205
Scott	210, 246
Sharp	242, 243
Sherwood	220
Sony	228
Soundesign	244
Teac	212, 216, 218
Technics	224, 225, 227
Victor	240, 241, 245
Yamaha	202, 203, 204

Codes For Personal Video Recorders	
Brand	Code
Panasonic Replay TV	100
Philips Tivo	102
Sony Tivo	101

Basic Menu Navigation

ENGLISH

Press **MENU** to display the Main Menu.



Press **CH** to select the desired icon.

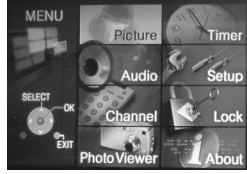
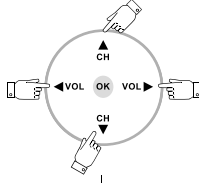

Press **CH** to enter the sub-menu field.

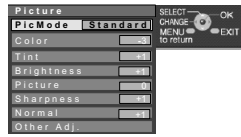

sub Menu Field

Press **CH** to select desired sub-menu feature.

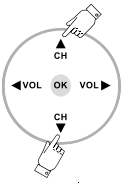

Press **VOL** to adjust or set desired sub-menu feature.

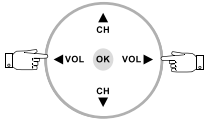

Note: For sub -menu with OTHER ADJ.

Press **CH** to select Other Adj.

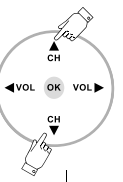

Press **CH** to access Other Adj. sub-menu.

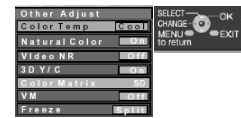
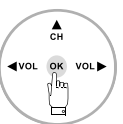

Press **CH** to select desired sub-menu.

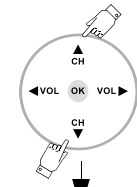

sub sub- Menu Field

Press **VOL** to adjust or select desired sub-menu.

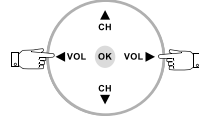

Note: To EXIT menus.

Press **MENU** repeatedly until normal picture is displayed.



or

Press **EXIT** to return to normal picture.



NORMAL PICTURE



Menu Operations

PICTURE

Note: While sub-menu features are highlighted, press ◀ VOL or VOL ▶ to adjust or activate.

- ❑ PIC MODE - Lets you choose one of three pre-set Picture Modes that best suits the program you are viewing. Selecting this feature will also affect Color Temperature setting.
 - VIVID - This is the default mode. It provides enhanced picture contrast and sharpness for viewing in a well-lit room.
 - STANDARD - Recommended for normal viewing conditions with subdued room lighting.
 - CINEMA - Select this mode for watching movies in a darkened room. It provides a soft, film-like picture.

Note: Each mode has its own picture settings (Color, Tint, Brightness, Picture and Sharpness).

- ❑ COLOR - Adjusts desired color intensity.
- ❑ TINT - Adjusts natural flesh tones.
- ❑ BRIGHTNESS - Adjusts dark areas of picture.
- ❑ PICTURE - Adjusts white areas of picture.
- ❑ SHARPNESS - Adjusts clarity of outline detail.
- ❑ NORMAL - Reset adjustments to factory default settings.

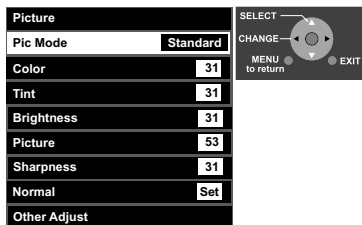

❑ Other Adjust

Highlight OTHER ADJ. and press OK button to display the sub sub-menu.

Note: While sub sub-menu features are highlighted, press ◀ VOL or VOL ▶ to select or activate.

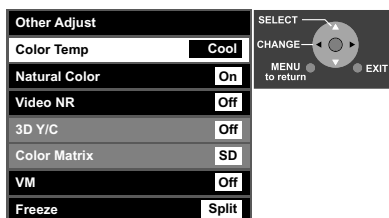

- COLOR TEMP (temperature) - To increase or decrease WARM (red) and COOL (blue) colors to suit personal preferences.
- NATURAL COLOR - To increase the color reproduction range with natural color gradation and highly delicate hues.
- VIDEO NR - Reduces noise in the channel, commonly called snow.
- 3D Y/C FILTER - Minimizes noise and cross color in the picture.
- COLOR MATRIX - Available only with 480p signal. Select HD or SD to automatically adjust color parameters for HD (high definition) and SD (standard definition). This feature is not selectable when viewing regular TV (NTSC) program.

Note: When viewing a non-standard DTV signal format, you can change color parameters manually for the best picture quality.

- VM (VELOCITY MODULATION)-To increase picture sharpness and provides crisp white to black transitions
- FREEZE - This feature is used to freeze main picture and display it in a PIP or SPLIT frame, when the FREEZE button on the remote control is pressed. Press FREEZE again to delete frame.

Note: SWAP, SIZE, SEARCH, PIP MIN and PIP MAX buttons are not functional in this mode.

AUDIO

Note: While sub-menu features are highlighted, press ◀ VOL or VOL ▶ to adjust or activate.

- ❑ BASS - Increase or decrease the bass response.
- ❑ TREBLE - Increase or decrease the treble response.
- ❑ BALANCE - Emphasize the left/right speaker volume.
- ❑ NORMAL - Reset BASS, TREBLE and BALANCE adjustments to factory default settings.

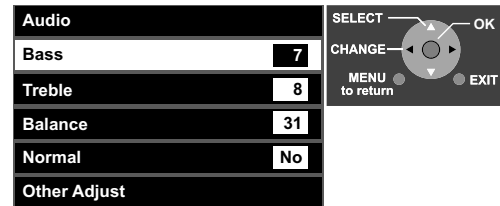

❑ Other Adjust

Note: While sub sub-menu features are highlighted, press VOL ▶ to adjust or activate.

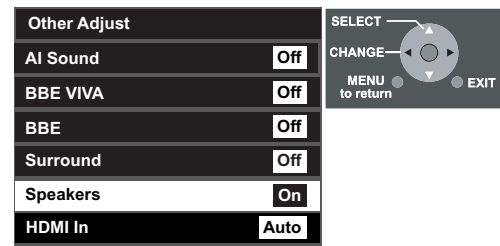

- AI SOUND - Equalize overall volume levels across all channels. (AI sound is not available in VIDEO mode).
- BBE® - Sound technology enhances speech intelligibility and restores the dynamic range of musical passages to provide outstanding natural sound.
- BBE VIVA 3D - BBE VIVA provides a musically accurate natural 3D image with hi-fi sound. The clarity of the sound is improved by BBE while the width, depth and height of the sound image are expanded by BBE's proprietary 3D sound processing. BBE VIVA is compatible with all TV programs including news, music, dramas, movies and sports as well as electronic games. BBE VIVA enhances the surround sound effect, while maintaining the clarity of dialogue.

Note: BBE VIVA 3D is only used in models PT-53TWD63 and PT-56TWD63.

AUDIO (cont.)

Other Adjust (cont.)

- SURROUND - Enhances audio response when listening to stereo.
- SPEAKERS - This feature is used to turn TV speakers ON or OFF.
 - On - TV speakers operate normally.
 - Off - TV speakers off.
- HDMI In - When using HDMI, this feature will let you switch between Analog Input and Digital Input.
 - Auto - Automatically selects Analog / Digital signal.
 - Digital - Digital Input only.
 - Analog - Analog Input only.

CHANNEL

Favorite - Allows you to create Favorite channel list from Antenna (A) or Antenna (B).

- ❑ **Surf Mode** - Select FAVORITE or ALL CHANNELS with remote control ◀ VOL or VOL ▶, then press the OK button.
- ❑ **RF Input** - Select Antenna (A) or Antenna (B).
- ❑ **Channel** - Use the remote control ◀ VOL or VOL ▶ to select desired channels, then press the OK button to add. To delete channel, press OK again while channel number is displayed.

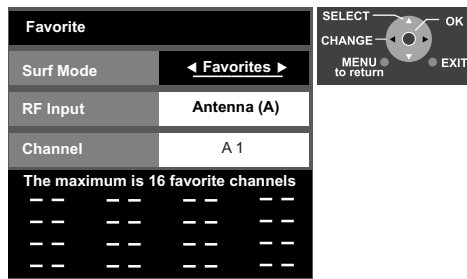

Captions - To enter preset and manual labels to desired stations. Also to enter input label to video inputs.

- ❑ **Preset Labels** - To enter channel numbers for popular TV stations.

Procedure

- Press OK button while Preset Labels is selected to select RF Input, then press ◀ VOL or VOL ▶ to select Antenna (A) or Antenna (B).

Note: Only input with signal will be selectable.

- Press OK button to underline your selection.
- Press CH ▼ to select desired preset caption.
- Then use the remote numeric keypad to select desired channel (refer to your local TV guide).
- Press OK to enter the selection.

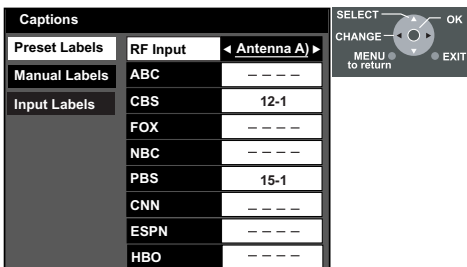

Note: To delete a channel number, while highlighted press ◀ VOL repeatedly until all numbers are removed, then press OK button.

- ❑ **Manual Labels** - To enter numbers and captions manually.

Procedure

- Press OK button while Manual Labels is selected to select RF Input, then press ◀ VOL or VOL ▶ to select Antenna (A) or Antenna (B).

Note: Only input with signal will be selectable.

- Press OK button to underline your selection.
- Press CH ▼ to select Channel, then press ◀ VOL or VOL ▶ to select available channel number.
- Press CH ▼ to select CAPTION.
- Press VOL ▶ to select first character position, then press CH ▲ or CH ▼ to select character (refer to your local TV guide for labeling channels).
- Repeat until all characters are added, up to (7) characters can be added for each channel.
- Press OK button to underline your selection.

Note: To delete the Channel Caption, highlight the first character and press CH ▲ or CH ▼ until no character is displayed. Move to the next character and repeat the process. After all characters have been deleted, press OK to enter the choice.

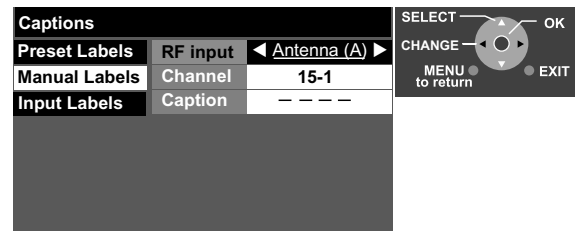

- ❑ **Input Labels** - To label video input connections for onscreen display.

Procedure

- Press OK button while Input Labels is selected to select COMPONENT 1, then press ◀ VOL or VOL ▶ to select preset INPUT LABEL for component 1.
- Press OK to underline your selection.
- Press CH ▼ to select another input, then repeat procedure for adding more labels to inputs.

Note:

- To delete Input labels, select desired input, then press ◀ VOL or VOL ▶ until no label is displayed.
- Press OK button to enter your selection.

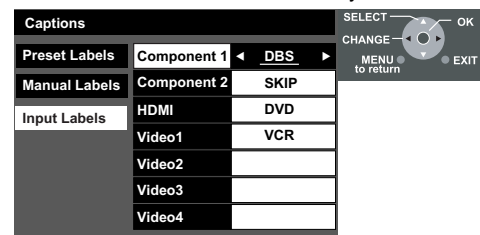
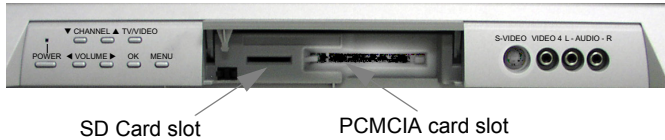

Photo Viewer™ Operation

Photo Viewer™ lets you display JPEG images recorded by digital camera on SD card or other types of memory card when it is inserted in the proper card slot.



Notes:

- Photo Viewer™ can only show still images recorded by Digital Still Camera with DCF and EXIF standard JPEG file.
- Other types of Memory cards can be inserted into the PCMCIA card slot by using the appropriate Card adaptor.
- Memory cards are not supplied with this television.

Compatible memory cards that can be viewed with Photo Viewer™

Card type	Maximum Size
SD, MMC (Multi Media Card), Smart Media*, Compact Flash* Memory Stick*, xD-Picture Card* Flash ATA*, Memory Stick Pro* *These cards require standard PCMCIA adaptor. (Some PC card adaptor will not be compatible). Note: Photo Viewer™ is not compatible with card type hard disk (Micro Drive, Mobile type hard disk, etc).	SD - 512MB, MMC - 64MB Smart Media - 128MB, Compact Flash - 1 GB Memory Stick - 128MB xD-Picture Card - 128MB Flash ATA - 128 MB Memory Stick Pro - 1GB

Inserting and Removing SD or PCMCIA card

WARNING: As with any small object, SD cards can be swallowed by young children. Do not allow children to handle the SD card. Please remove the SD card immediately after use.

Procedure

- ❑ SD card - Push in the SD card into the SD card slot until it is clicked in. Press again on the card to remove it.
- ❑ PCMCIA card - Push in the card firmly until it is seated. To release the card, press the release button on the right side of the card slot. Before inserting or removing the PCMCIA card, make sure that the TV is turned Off. Otherwise, it may damage the unit. Do not insert anything other than the PCMCIA card.

Information Regarding memory cards

- Memory cards must be formatted with FAT12 or FAT16 in order to be viewed on TV. If the card is not formatted, it may cause incompatibility with certain memory card adaptors. If this happens, reformat the card using your digital camera. Refer to your camera manual for more information.
Note: Reformatting the card will erase the images stored in it.

Basic Operation

Insert either the SD card or the PCMCIA card into the appropriate slot. The video disappears from the screen while the Photo Viewer™ access the information from the card. After accessing the images from the card, a thumbnail screen is displayed on-screen. Use the navigation keys to select the desired thumbnail

and press **OK** button to display the image on-screen. Use **◀VOL** or **VOL▶** to select the previous or next picture. Press **EXIT** button to exit Photo Viewer™ mode.

Photo Viewer™ - Thumbnail mode

The thumbnail screen is the initial entry screen from the main menu. It shows the total number of images on the card, Filename (folder number and the number of the thumbnail that is highlighted), the date the picture was taken and the pixel (resolution) of the picture.

Procedure

- Press **MENU** button to display the Main menu.
- Highlight Photo Viewer™ Icon using the navigation (Left/Right/Up/Down) keys.
- Press **OK** button to display the thumbnail screen.

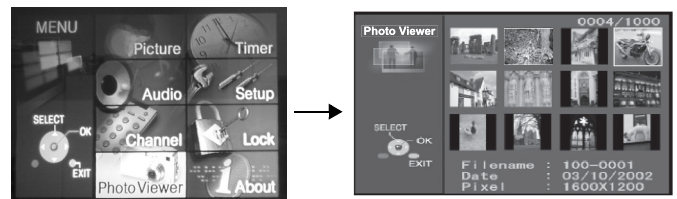

Note: It may take long time to display the thumbnail if there are lots of files or if the file size is big.

- Select the desired thumbnail image by using the Left/Right/Up/Down navigation keys.
- Press **OK** button to start the Single Picture View mode.
- Change the picture by pressing **◀VOL** or **VOL▶** keys.
- Rotate the picture if necessary, by using the **CH▼** or **CH▲** keys.

Notes:

- Maximum number of folders that can be displayed: **100**.
- Maximum file size: **3000**. Any folder of files larger than the specified size, will not be displayed.
- **Picture resolution:** Compatible in the range 64x64 - 8192 x 8192 (sub-sampling 4:2:2 or 4:2:0)
- If the image is imported from a PC, it must follow the EXIF (Exchangeable image file format) 2.0, 2.1, 2.2 in addition to the DCF (design rule for Camera File system) format, or it will not be displayed.
- If the JPEG is modified using a PC, it will not be displayed on TV.
- The Photo Viewer™ cannot display Motion JPEG and still image not DCF formatted (i.e. TIFF, BMP).
- If the file is partially corrupted, it may be shown in lower resolution.
- If both SD card and PCMCIA card is inserted at the same time, SD card has the priority. Otherwise, the card inserted later will have priority.
- Do not remove the SD card or PCMCIA card while Photo Viewer™ is accessing the information (when the card icon is flashing). Such action may damage the memory card or the unit itself.

Photo Viewer™ Operations (Cont.)

Photo Viewer™ Setup Menu

This menu allows you to customize features in the Photo Viewer™ Setup menu.

Procedure

- Highlight Photo Viewer™ icon and press **OK** button to display the thumbnail screen.
- Press the **SD** button on the remote control to display the Setup screen.
- Use the **CH**▲, **◀ VOL** or **VOL ▶** keys to navigate in the setup menu.

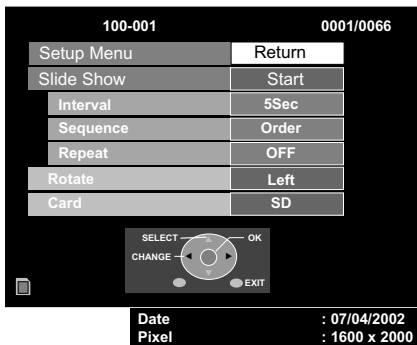

- Slide Show - Allows you to start the slide show by pressing the **OK** button while Start is highlighted. Press **OK** button to stop the Slide Show.

Note: When you are in the Slide Show mode, you can change the Aspect of the image on screen by pressing the **ASPECT** button on the remote control.

- Interval - Allows you to change the length of time that a slide is being displayed on screen. Available settings are: 5sec, 10sec, 15sec, 30sec, 60sec, 90sec and 10 minutes.
- Sequence - Select either Order or Random.
- Repeat - Select Off or On.

Note: After setting Interval, Sequence or Repeat, press **CH ▲** button to select Start, then press **OK** to start the Slide Show.

- Rotate - Allows you to rotate the image.
- Zoom - Lets you select the magnification of the Single Slide display.

Procedure

- While in the Single Slide display mode, press **SD** button to display Photo Viewer™ Setup Menu. Zoom option will be displayed in the Setup Menu.
- Highlight Zoom and press **OK** button.
- Press **◀ VOL** or **VOL ▶** button to select To Fit, x2 or x4.
- Press **OK** button. To move the image in the picture frame, press the navigation buttons.
- Press **OK** to view the slide in normal magnification.
- Card - Select either SD or PC when both cards are inserted in the slots.

Following are some of the error messages that may be displayed on-screen when certain conditions are not met or exceeds the Photo Viewer™ specifications.

Error messages

Error condition	Error messages displayed on-screen
When inserting Card	No card or Card is not inserted correctly
If the JPEG file is corrupted and cannot be decoded.	This type of image is not supported.
If the card is not formatted with FAT 12 or FAT 16 or if it is not DCF standard.	This type of format is not supported.
If thumbnail and main picture cannot be shown	 This icon will appear where thumbnail image will.
Over 3000 image files	Photo Viewer™ cannot support over 3000 JPEG files.
Resolution over	Photo Viewer™ cannot support over 8192 x 8192 pixels.
If incompatible card is inserted	This type of card is not supported.

Photo Viewer™ Troubleshooting

Symptoms	Solutions
Cannot read the content of the card	A) Not compatible format. Must be formatted with FAT 12 or FAT 16. B) The extension is not "JPG". Photo Viewer™ can display EXIF standard JPEG file, and JPEG file which is not EXIF standard cannot be shown. C) The folders not under DCF standard.
PC card cannot be ejected	Push the card all the way in, and eject.
Poor picture quality	If the main image cannot be read (the file is partially corrupted), the Photo viewer™ will read the thumbnail. Please confirm the format of the image.
Long time to display	It will take long time to display, if there are lots of images or if the file size is big.

Notes:

- If thumbnail screen or a single slide image is displayed for longer than 10 minutes, Image shift (refer to page 26) feature will be activated to prevent image retention. The image on-screen will zoom-in and zoom-out in 4 (four) steps. To exit this mode, press OK button or select another slide or press any button.
- During the Slide show, the Image shift feature will activate if the image is displayed longer than 5 (five) minutes. The image will be shifted horizontally (left or right) in minute increments. Image shift feature will not activate, if it is turned Off.

Timer

This menu lets you set the sleep timer, Timer (On/Off), clock and the day of the week.

- ❑ **Sleep** - Select to turn the PTV off in 30, 60, or 90 minutes. Select No to turn the sleep timer off.

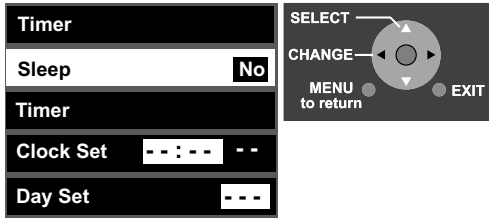

Procedure

- Press **MENU** button to display the Main Menu.
- Highlight the Timer icon using the navigation buttons.
- Press **OK** button to display the Timer menu.
- Press **VOL ▶** button to select 30, 60, 90 minutes or No.

- ❑ **Timer** - Select timer to turn the PTV on and off at selected times and on selected day.

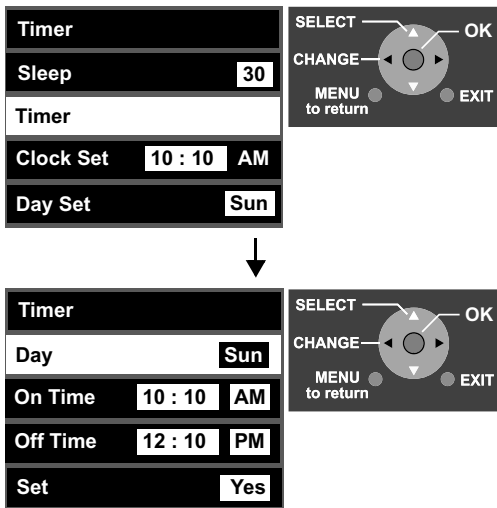

Procedure

- While in the Timer menu, press **CH ▼** button to highlight Timer.
- Press **OK** button to display the Timer sub-menu.
- Press **◀ VOL** or **VOL ▶** button to select appropriate day setting.
- Press **CH ▼** to highlight On Time.
- Press **OK** button to enter the time field. Press **CH ▲** or **CH ▼** button to set the hour (AM or PM).
- Press **VOL ▶** and press **CH ▲** to set the minutes.
- After setting hour and minutes, press **OK** or **MENU** button to quit the settings.
- Press **CH ▼** to highlight Off Time and repeat the same procedure as for setting time.
- Press **CH ▼** to highlight Set and select Yes or No.
- Press **EXIT** button to exit the menus.
- Enter the desired channel number using the numeric keypad and the **PROG** button (if necessary). The television will tune to this channel when timer is activated.

- Turn Off the set.
- The television will turn On at the selected time and the channel will be the channel selected before turning the TV off.

Notes:

- Clock must be set before you can set Timer. Use navigation buttons to highlight the Timer Icon.
- The television automatically turns OFF after 90 minutes when turned ON by the Timer. If the OFF time is selected or if a key is pressed, the automatic OFF after 90 minutes will be cancelled.

- ❑ **Clock Set** - Select to set the Time of the day.

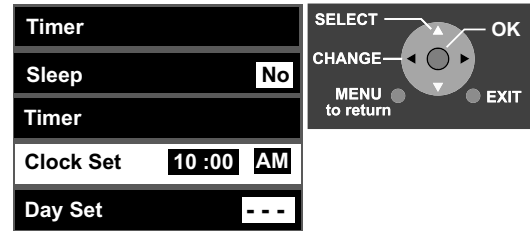

Procedure

- While in Timer menu, press **CH ▼** to highlight Clock Set and press **OK** button.
- Press **CH ▲** or **CH ▼** button to set the hour (AM or PM).
- Press **VOL ▶** to enter the next field. Press **CH ▲** or **CH ▼** button to the minutes. Press **MENU** or **OK** to return to the Timer screen.

- ❑ **Day Set** - Select to set the day of the week.

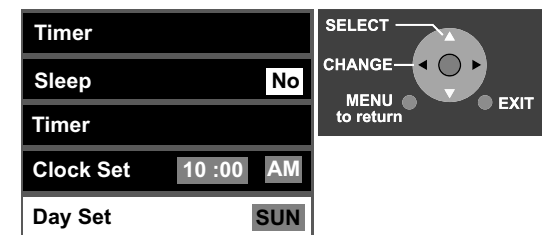

Procedure

- Press **CH ▼** to highlight Day Set and select the day of the week using **◀ VOL** or **VOL ▶** button.
- Press **EXIT** button to quit the timer menu screen.

Set Up

This menu lets you select antenna, program channels, select analog and digital closed caption, Convergence, Auto Power On, Image Shift and Zoom Adjust.

Procedure

- Press **MENU** to display the Main Menu.
- Press **▼CH, CH▲, ◀VOL** or **VOL▶** to select the Setup icon.
- Press **OK** button to display the options in the Setup menu.

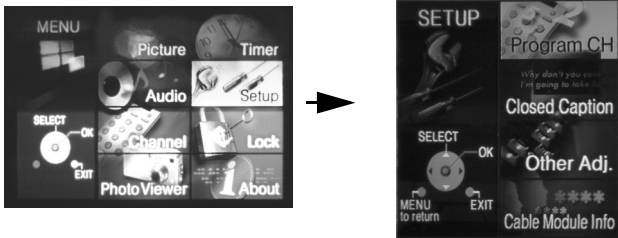

Program CH

This menu allows you set up the antenna, auto scan all available analog and digital channels, manually add or delete channels and display the signal strength of the digital channels.

- ☐ **Input Setup** - Lets you specify Antenna mode (Cable only, Cable/Antenna or Antenna only).

Note: You can connect either a Cable antenna or a terrestrial antenna to Ant A. However, if you have both Cable signal and terrestrial antenna signal, the Cable signal **must** be connected to the Ant A input on the back of the projection television. Connect the antenna signal to the Ant B input.

Procedure

- In Set Up menu, select Program Channel and press **OK**.
- Press **OK** to enter sub-menu. Press **◀VOL** or **VOL▶** to select Cable Only, Cable/Antenna or Antenna Only.
- Press **OK** button to enter your selection. When the next screen will be displayed, press **OK** button to start the Auto scan. Auto scan must be done when you select the input signal for the first time or whenever you change the antenna configuration.

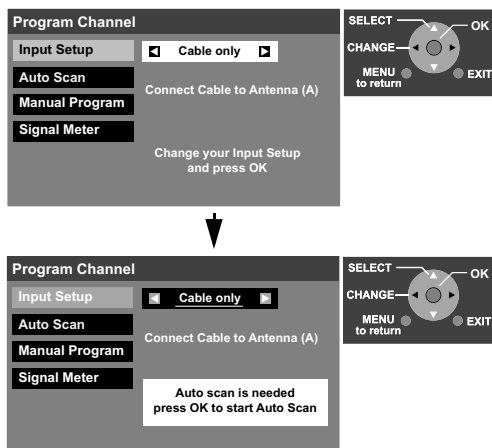

Notes:

- If Cable Only, Antenna Only or Antenna/Cable is selected and DCM (Digital Cable Module) is not in, the Auto scan will perform Scan All.

- If Cable Only is selected and DCM is in, Auto scan will be skipped.
- If Cable/Antenna is selected and DCM is in, Antenna (B) Analog & Digital Auto scan will be performed.

- ☐ **Auto Scan** - To automatically Scan All available channels, Antenna (A) Analog, Antenna (A) Analog & Digital, Antenna (B) Analog and Antenna (B) Analog & Digital.

Procedure

- Highlight Auto Scan and press **OK** to enter the sub menu.
- Use **▼CH** and **CH▲** to select and press **OK** to start the auto scan. After Auto Scan is completed press **MENU** to return to the previous screen.

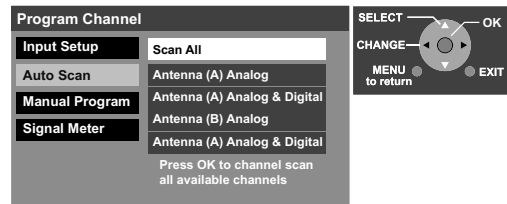

- ☐ **Manual Program** - To add or delete channels from either channels list (A/B) manually.

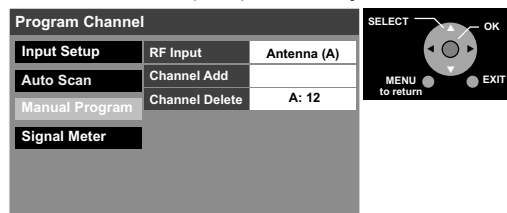

- ☐ **Signal Meter** - Displays the signal strength of the ATSC digital channel in either Antenna (A) or Antenna (B).

Note: Signal meter feature is not available for analog channels.

Procedure

- Highlight Signal Meter and press **OK** button to enter the sub-menu.
- In the RF Input field, select either Antenna (A) or Antenna (B).
- Select the channel number using **◀VOL** or **VOL▶** buttons.
- Press **OK** button to display the Signal Strength.

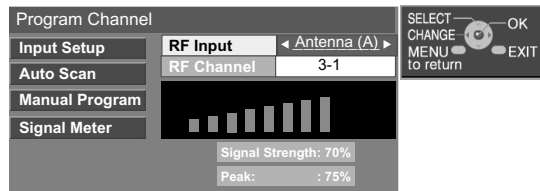

Note: The color of the signal bar usually indicates the strength of the received signal.

- Green - Adequate signal for a good reception.
- Yellow - Poor signal strength.
- Red - Very poor signal strength.

Closed Caption

The HDTV Projection Television includes a built-in decoder that is capable of providing a visual display of the audio portion. The program viewed must provide Closed Captioning (CC) for the television to display it. You can set your preferences to both digital and analog Closed Captioning.

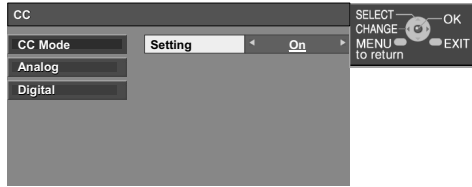

CC Mode

Select Off, On or On Mute.

- Off - Use when Closed Captioning is not desired.
- On - To display Closed Captioning.
- On Mute - To display Closed Captioning when audio is muted.

Analog

This option lets you choose the closed caption service you desire.

Procedure

- In Closed Caption menu, highlight Analog and press **OK** button to enter the sub-menu.
- Press **◀ VOL** or **VOL ▶** to select the desired setting: CC1, CC2, CC3, CC4, T1, T2, T3 or T4.
- CC1 - For video related information that can be displayed (up to 4 line of script on the screen, where it does not disturb the relevant parts of the picture). Script can be in any language.
- CC2 to CC4 - Other modes used for video related information.
- T1 - Blanks out a large portion of the picture on the television screen, and displays program guide or any other information currently being transmitted.
- T2, T3 and T4 - Other modes that display information and blank out a large portion of the picture of the television screen.
- Press **MENU** button to return to the Closed Caption menu.

Digital

The Digital Closed Captioning menu lets you configure the way you choose to view the digital captioning. This menu will let you choose the type of closed captioning service, font type, font size, font style. The colors sub-menu lets you set the color of the font (Foreground), color the text box (Background) on which the closed caption is text is displayed, the opacity of the font (Fore Opacity), the opacity of the text box (Back Opacity), and the outline of the dropshadow (if selected under style).

Colors sub-menu

Procedure

- In digital closed captioning sub-menu, select Colors and press **OK** button to display the colors sub-menu.

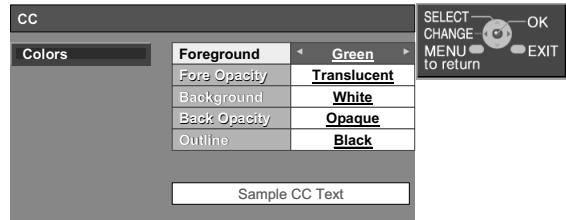

Note: When digital caption is used on ATSC, the monitor output (Prog Out) will also output the CC information. This means, if you tape the program, the CC information will also be recorded on tape. To avoid this, either turn off digital CC or turn on analog CC.

Other Adj.

The Other Adjust menu lets you set Auto Power On, adjust Convergence, select Image Shift On or Off and Zoom Adjust.

- Auto Power On - Select Set to power up the PTV at the same time as the Cable box or other components or select Off.
- Image Shift - This feature prevents the image retention associated with viewing fixed image for extended period of time. The image is shifted left or right in small increments if a fixed image is left on for a long time. Selecting **On** is recommended.
- Convergence - This feature is used to adjust the convergence if needed.
- Zoom Adjust - This feature lets you adjust the size of the zoom picture and position it vertically.

Procedure

- In Set up menu, highlight Other Adj. and press **OK** button to display the sub-menu.
- Use **▼ CH** or **CH ▲** to navigate. Press **◀ VOL** or **VOL ▶** to select or press **OK** button to display the sub-menu for Convergence and Zoom Adjust.

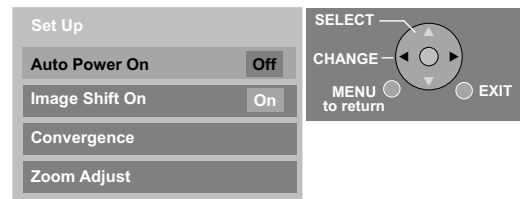

Convergence

Note: Only use the remote control buttons while adjusting convergence. The front control panel navigation and **OK** buttons have no effect.

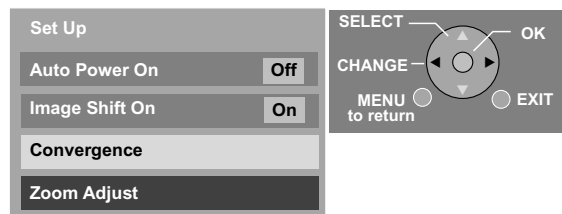

Convergence (cont.)

Note: Convergence seldom needs adjusting except after moving the PTV or to make minor adjustments.

Procedure

- Press **OK** to enter convergence sub-menu field.
- Press **CH ▲** or **CH ▼** to select:
 - CONVERGENCE ADJ. - Select to correct minor convergence problem.

Note: After selecting, press **OK** to continue CONVERGENCE ADJ.

- RESET TO DEFAULT - Select to set convergence to factory default setting.

Note: After selecting, press **OK** to activate RESET TO DEFAULT feature.



CONVERGENCE ADJ.

Procedure

- After pressing **OK** the align Green to Center screen will be displayed.
- Then use the navigation buttons on the **remote control** to align the horizontal and vertical green lines on screen, with the cabinet reference marks on top center and left center of cabinet, as shown below.

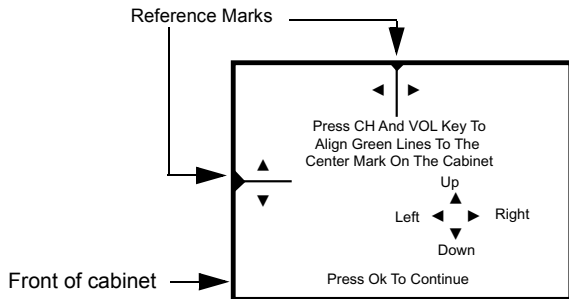

- Press **OK** button to display red center correction screen.
- Use the navigation buttons on the remote control to align the red cross with the white cross pattern at the center of the screen.

Note: To prevent picture tube damage do not leave test pattern on for an extended period of time.

- Then press "0" on the remote control keypad to display the **BLUE** center correction screen, repeat procedure for adjusting blue. If needed press "0" again to return to **RED** correction screen.

Note: An adjusted cross pattern appears white with a minimum of color protrusion.

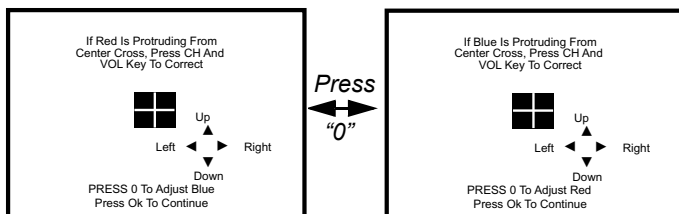

NINE POINT CONVERGENCE CORRECTION

Note: Remote Control must be in TV mode.

Procedure

- Press **OK** button to display red correction screen.
- Press the 1 through 9 keypad buttons on the remote control to select the desired convergence position.
- Use the navigation buttons to align the **RED** cross with the white cross pattern.

Note: An adjusted cross pattern appears white with a minimum of color protrusion.

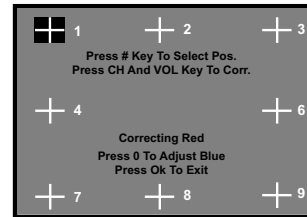

- Press "0" on the remote control keypad to display the **BLUE** correction screen, then repeat procedure.

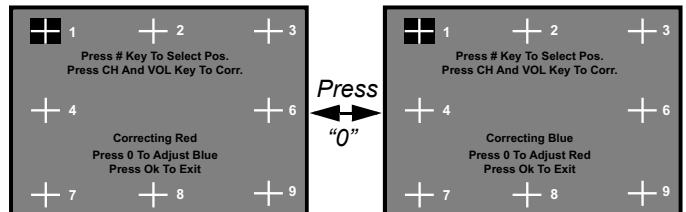

- To exit convergence screen press **OK** button, then press **EXIT** to quit all menus.

Cable Module Info

This menu is used to provide information when a DCM (Digital Cable Module) is inserted into the DCM INTERFACE (POD INTERFACE) slot on the back of the projection television. If no DCM is present and you try to access the Cable Module Info, the message 'Cable Module Not present' will be displayed on screen. To receive the features offered by your cable company, you may have to subscribe to those services.

Note: Please contact your cable company regarding availability of the DCM (Digital Cable Module). The cable module is needed to receive premium digital services (where available) through the cable input. You may also be able to order call-ahead pay per view events.

Lock

This HDTV Projection Television incorporates V-CHIP technology to block the viewing of movies and television programs according to the rating category. There are two (2) Content Advisory Categories: MPAA (Motion Picture Association of America) and TV Parental Guidelines Ratings. These categories are used as guidelines for blocking the programs. The default mode for the Lock category is the Unlocked state. In this state, you can surf the various categories of the Lock menu. After you've created a password, you are prompted to enter it before you can make any changes in the Lock menu.

Creating a Password

A password is created using the New Password menu.



Procedure

- Press **MENU** button to display the Main Menu.
- Press navigation buttons to highlight the LOCK icon.
- Press **OK** to display the New Password screen.
- Use the numeric keypad to create a 4 digit password.
- Press **OK** to enter the password. Now the PTV is in the locked state.

Lock Set

- ❑ **Mode** - To prevent video games, VCR tapes and all channels and video modes from being viewed. The possible modes are:
 - Off - Turns off Lock set functions.
 - All - All channels are locked regardless of the rating level.
 - Game Lock - Locks out CH 3, 4 and Video inputs.
 - Channel Lock - Locks out specific analog and digital channels. Password is required to view any of the locked channels.

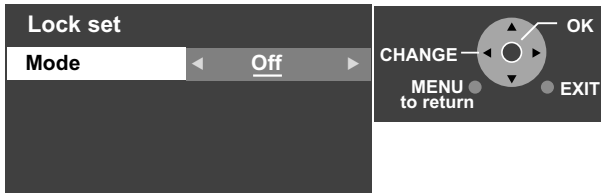

Procedure

- While in the Lock menu screen, highlight Lock Set and press **OK** button to display the Lock Set sub-menu.
- Press **◀ VOL** or **VOL ▶** button to select the option and press **OK** button to underline the option.
- Press **MENU** button to return to the previous screen.

Channel Lock

This option lets you select the RF Input (Antenna (A) or Antenna (B) and block out up to four (4) channels from each input. Password is required to view these blocked channels.

- ❑ **RF Input** - Select either Antenna (A) or Antenna (B).

- ❑ **Channel** - Select up to four (4) channels to be blocked out. These channels will be blocked out regardless of the program rating.

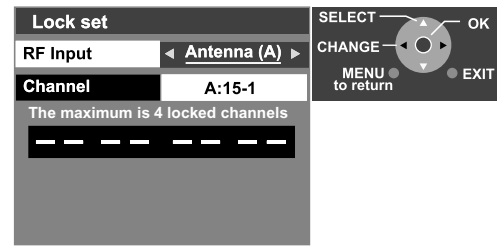

Procedure

- In Lock Set, choose Channel Lock and press **OK** button.
- Press **MENU** button to return to the previous menu.
- Highlight Channel Lock and press **OK** button to display the Channel Lock sub-menu.
- Press **OK** and select Antenna (A) or Antenna (B) using **◀ VOL** or **VOL ▶** button.
- Press **CH ▼** button and press **OK**.
- Select the channels to be blocked by using the left/right navigation buttons and press **OK** to enter your selection. A maximum of four (4) channels can be blocked from each input. These channels will be blocked regardless of the ratings.

Note: To remove the channel # from the list, select the same channel # and press the **OK** button.

Block Program

This feature allows you block movies and television programs based on the MPAA and U.S. TV ratings system.

- ❑ **MPAA** - The MPAA uses the standard movie ratings to block the movies from being displayed.

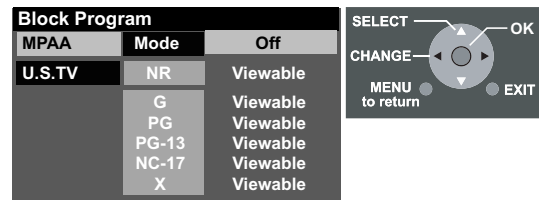

Procedure

- In Lock menu, select Block Program and press **OK** button to display the sub-menu.
- Press **OK** button to enter the Mode field and select Off or On using **◀ VOL** or **VOL ▶** button. Press **OK** to enter the selection.
- Press **CH ▼▲** buttons to highlight the desired rating level.
- Press **OK** button to change the rating limit to "Viewable" or "Blocked".

Note: The NR rating is independent of other ratings. Placing a block on a specific age based rating level, this rating and any other more restrictive ratings will also be blocked.

Please see the following chart for the MPAA Ratings Description.

U.S. Movies Rating Chart Description

NR	Not Rated by MPAA.
G	GENERAL AUDIENCES. All ages admitted.
PG	PARENTAL GUIDANCE SUGGESTED. Some material may not be suitable for children.
PG-13	PARENTS STRONGLY CAUTIONED. Some material may be inappropriate for children under 13.
R	RESTRICTED. Under 17 requires accompanying parent or adult guardian.
NC-17	NO ONE 17 AND UNDER ADMITTED.
X	ADULTS ONLY.

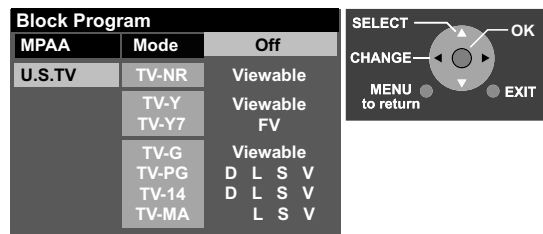

Notes:

- The ratings such as TV-PG, TV-14 and TV-MA have content level ratings also. These contents levels can be individually blocked. Select the rating level, press **VOL** ► to highlight the desired content level and press **OK** button to block.
- The TV-NR rating is independent of other ratings.
- If TV-Y is blocked, both TV-Y and TV-Y7 will be blocked. However, if you select TV-Y7, the FV setting can be blocked or unblocked.

U.S. TV Rating

The TV Parental Guidelines has 7 levels of age-based ratings that can be selected. These 7 levels are split into 2 age-based groups: Youth Age-based Ratings and Guidance Age-based Ratings. Some of these age-based ratings can also have content-based ratings, denoted as D (Dialog), L (Language), S (Sex) and V (Violence). The table below shows the age-based ratings selection.

Age-based Group	Age-based Ratings	Possible Selections	Content
NR (Not Rated)	TV-NR	<ul style="list-style-type: none"> • Viewable • Blocked 	
Youth	TV - Y	<ul style="list-style-type: none"> • Viewable • Blocked 	
	TV - Y7	<ul style="list-style-type: none"> • FV (Fantasy Violence) • Viewable • Blocked 	
Guidance	TV - G	<ul style="list-style-type: none"> • Viewable • Blocked 	
	TV - PG	<ul style="list-style-type: none"> • D,L,S,V (all selected) • Any combination of D, L, S, V 	
	TV - 14	<ul style="list-style-type: none"> • D, L S, V (all selected) • Any combination of D, L, S, V 	
	TV - MA	<ul style="list-style-type: none"> • L, S, V (all selected) • Any combination of L, S, V 	

U.S. TV Ratings Description

TV-NR	Not Rated.
TV-Y	All Children. The themes and elements in this program are specifically designed for a very young audience including children from ages 2-6.
TV-Y7	Directed to older children. Themes and elements in this program may include mild physical or comedic violence or may frighten children under the age of 7.
TV-G	General Audience. It contains little or no violence, no strong language, and little or not sexual dialogue or situations.
TV-PG	Parental guidance suggested. The program may contain infrequent coarse language, limited violence, some suggestive sexual dialogue and situations.
TV-14	Parents strongly cautioned. This program may contain sophisticated themes, sexual content, strong and explicit sexual content.
TV-MA	Mature Audiences only. This program may contain mature themes, profane language, graphic violence and explicit sexual content.
FV	Fantasy/Cartoon Violence.
V	Violence
S	Sex
L	Offensive Language
D	Dialogue with sexual content.

Procedure

- In Block Program, highlight U.S.TV and press **OK** button to enter the Mode.
- Press **OK** button to select Off or On and press **OK** button.
- Select the desired rating level using **CH** ▼ or **CH** ▲ buttons.
- Press **OK** button to choose "Viewable" (**GREEN**) or "Blocked" (**RED**).

Lock (Cont.)

How long?

This feature allows you lock the television input sources for specific period of time. Available selections are: 12 hours, 24 hours, 48 hours or Always.

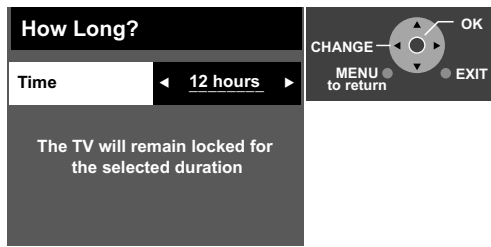

Note: If you select Always and you forget your password, the TV must be serviced by a qualified technician to clear the Lock setup.

Password

This screen lets you change your password. Enter a new 4 digit password using the numeric keypad and this code becomes your new password.

Blocking Messages

Various Blocking messages are displayed on-screen depending upon the type of blocking you have selected in the LOCK menu.

When Game Lock is selected

Following message is displayed when you attempt to select video inputs..



When Channel Lock is selected:

The on-screen display will be displayed when you attempt to tune the channels that are locked in the Channel Lock menu.

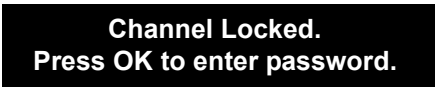

When the rating level is exceeded

If the program you are viewing exceeds the set rating level, a rating level exceeded message is displayed. You are prompted to enter your password to view the blocked channel.

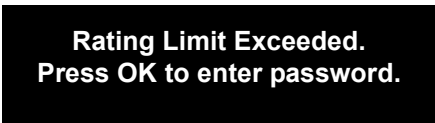

Note: Entering the password will override the block condition. However, the ratings selection will be retained.

About Screen

The About screen displays assorted information about the HDTV Projection Television. Please have this information when calling Customer Care Center.

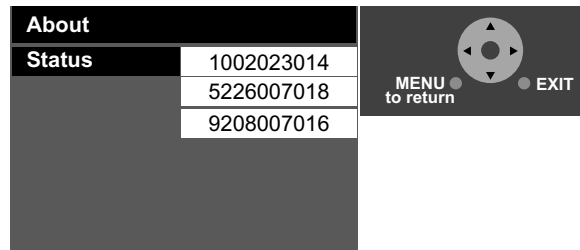

ENGLISH

Glossary and Acronyms

ATSC (Advanced Television Systems Committee)

Standardization body that developed the Digital Television Terrestrial formats.

DCF (Design rule for Camera File system)

Unified standard established by Japan Electronics and Information Technology Industries Association (JEITA).

DCM (Digital Cable Module)

A PCMCIA-type card that is provided by the Cable operator.

FAT (File Allocation Table)

FAT 12 or FAT 16: File systems used in formatting the memory cards.

HDMI (High Definition Multimedia Interface)

Interface that supports every uncompressed digital format as well as all existing multi-channel audio format on a single cable.

JPEG (Joint Photographic Experts Group)

A system used for compressing/decoding color still pictures.

MPAA (Motion Picture Association of America)

Guild governing rating assignments to movies.

NTSC (National Television Systems Committee)















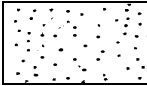

Standardization body that developed the Analog Television Terrestrial formats.

Password









A four (4) digit code a user must provide in order to perform a function.

Troubleshooting Chart

Before calling for assistance, determine the symptoms and follow suggested solutions.

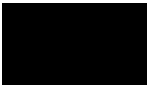
AUDIO	VIDEO	Solutions
 Noisy Audio	 Snowy Video	Adjust Antenna Location and Connection.
 Normal Audio	 Multiple Image / Color shift in picture	Adjust Antenna Location and Connection. Check Antenna Lead-in Wire. Adjust Convergence (refer to pages 26 and 27).
 Noisy Audio	 Interference	Move television from Electrical Appliances, Lights, Vehicles and Medical Equipment.
 No Audio	 Normal Video	Increase Volume. Check Mute. Check television SPEAKERS on/off. (refer to pages 20 and 21) Change Channel.
 Noisy Audio	 No Video with Snow	Set TV or Cable Mode Properly. Check Antenna Cables.
 No Audio	 No Video / No PIP	Check Power Cord is Plugged into Active Outlet. Adjust Brightness and Audio Controls. Change Channel. Check Cable Connections. Program the Remote Control Again. Check Second Video Source Operation. Poor ATSC signal strength. Re-orient the ATSC antenna.
 Audio Break up	 Digitalization of image Image freeze up	Re-orient the ATSC antenna. Check signal meter (refer to page 25). If the signal is weak, add a signal booster to boost the signal strength.
 Normal Audio	 Picture shifts slightly (horizontally) when turned on, changing channels or within a duration of two (2) hours of viewing.	This is a normal condition to prevent image burn-in. This feature can be turned off. However, turning off this feature may result in image retention on screen. (refer pg. 26)
 Normal Audio	 No Color	Adjust Color Settings. Change Channel.

ENGLISH

AUDIO	VIDEO	Solutions
 Wrong Audio	 Normal Video	Check Audio is set to Stereo or Mono, not SAP.
 Normal Audio	 Black Box on Screen	Change CC (Closed Captioning) from Text Mode.
When HDMI signal is connected.		
 No Audio	 No Video	Make sure that a PC is not connected to HDMI input. Rarely, the TV will not display video in HDMI input from devices with HDMI or DVI output due to bad communication between the TV and the devices. Should this happens, unplug the HDMI/DVI device and plug it back on.
 Wrong Audio	 Normal Video	If using HDMI input, change the audio of the HDMI device to Linear PCM. Check the Audio setting for HDMI (refer to page 21). If there is functional problem with Digital Audio, please use Analog audio.
Intermittent Remote Control Operation		
 Normal Audio	 Normal Video	Replace Remote Control batteries.

Numerics

3D Y/C Filter 20

A

AC Power Supply Cord 4
 Add Fav / Del Fav feature 11
 AI Sound 20
 Amplifier Connection (Analog) 8
 Analog 26

Antenna Connection 4
 Aspect Button 12
 Audio 20
 Auto Power On 26
 Auto Scan 4, 25

B

Balance 20
 Basic Menu Navigation 19
 Bass 20
 BBE 20
 BBE Button 12
 BBE VIVA 3D 20
 Block Program 28
 Brightness 20

C

Cabinet and Remote Control 3
 Cable / Antenna Connection 4
 Cable Connection 4
 Cable Module Info 27
 Captions 21
 Care and Cleaning 3
 CC Mode 26
 Channel and Program Tuning 11
 Channel Banner 11
 Channel Lock 28
 Channels 21
 Cinema 20
 Clock Set 24
 Closed Caption 26
 Codes For Cable Box 17
 Codes For Cassette Decks 18
 Codes For CD Player 18
 Codes For DBS 17
 Codes For DVD 17
 Codes For Personal Video
 Recorders 18
 Codes For Receivers 18
 Codes For VCR 17
 Color 20
 Color Matrix 20
 Color Temp 20
 Component Codes 16
 Component Connection Cables 4
 Convergence 26
 Coverage 26
 Creating a Password 28
 Customer Record 3

D

Day Set 24
 Digital 26
 Digital Audio Out Connection 8
 Digital Cable Module Connection 6
 Digital TV - Set-Top Box (DTV-STB) or
 DVD Connection 6
 Direct Tuning Method 11

E

Emergency Alert System (EAS)
 Forced Tuning 11

F

Favorite 21
 Feature Chart 3
 First Time Setup 4
 Freeze 20
 Freeze Button 10
 Front and Rear View of the HD
 Projection Television 5
 Front Control Panel 6
 Front Panel (PT-47WXD63 and
 PT-53WXD63) 5
 Front Panel (PT-53TWD63 and
 PT-56TWD63) 5

G

Glossary and Acronyms 31

H

HDMI (High Definition Multimedia
 Interface) input connection 7

I

Image Shift 26
 Information Regarding Convergence 1
 Information Regarding
 memory cards 22
 Input Labels 21
 Input Setup 4, 25
 Inserting and Removing SD or
 PCMCIA card 22
 Installation 4
 Interval 23

L

Lock 28
 Lock Set 28

M

Main Picture Freeze Feature 10
 Manual Labels 21
 Manual Program 25
 Menu button 12
 Menu Operations 20
 Move Button 10
 MPA 28

N

Natural Color 20
 Nine Point Convergence
 Correction 27
 Normal 20

O

Operating a Cable Box 14
 Operating a cassette deck 15
 Operating a DVD 14
 Operating a PVR (Personal Video
 Recorder) 15
 Operating a Receiver 15
 Operating a VCR 14
 Operating Components with
 Remote Control 14
 Optional Equipment Connections 6
 Other Adj. 20

P

Photo Viewer™ Operation 22

Photo Viewer™ Setup Menu 23
 Picture 20
 PIP and Split Operational Buttons 9
 PIP MIN and PIP MAX Buttons 10
 PIP Operation 9
 PIP, Split and Freeze Mode Buttons
 Operational chart 10
 Preset Labels 21
 PROG button 12
 Program CH 25
 Program Out Connection
 (PROG OUT) 8
 Programming The Remote 16
 Programming Without A Code 16
 Projection Screen 3

R

Rear Panel Jacks 5
 RECALL button 12
 Regarding The Use Of Video Games 1
 Remote Control Operation 13
 Repeat 23
 RF Input 21
 Rotate 23

S

SAP Button 12
 Search Button 9
 Sequence 23
 Set Up 25
 Sharpness 20
 Signal Meter 25
 Sleep 24
 Slide Show 23
 Speakers 21
 Special Remote Buttons 11
 Specifications 3
 Split Operation 9
 Standard 20
 Surf Mode 21
 Surround 21

T

Television Location 4
 Thumbnail mode 22
 Timer 20
 Timer 24
 Timer 1 and Timer 2 24
 Tint 20
 Treble 20
 Troubleshooting Chart 32, 33
 Tuning digital and analog channels 11
 TV/VIDEO Button 9

U

U.S. Movies Rating Chart
 Description 29
 U.S. TV Rating 29

V

VCR Connection 6
 Video NR 20
 VIVID 20
 VM (Velocity Modulation) 20

Z

Zoom 23
 Zoom Adjust 26

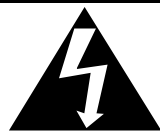
**ADVERTENCIA****RIESGO DE SACUDIDAS
ELECTRICAS. NO ABRIR.**

ADVERTENCIA: A fin de reducir el riesgo de descargas eléctricas, no deberán quitarse ni la cubierta ni la tapa posterior. No hay en el interior pieza alguna que el usuario tenga que reparar. Todo servicio habrá de brindarlo personal de reparación capacitado.



El propósito del relámpago con punta de flecha dentro de un triángulo es el de advertir al usuario de que existen piezas internas del producto que representan riesgo de que las personas reciban descargas eléctricas.



El propósito del signo de exclamación dentro de un triángulo es el de advertir al usuario de que los documentos que acompañan al aparato incluyen instrucciones importantes de funcionamiento y reparación.

ADVERTENCIA: Con el objeto de prevenir el riesgo de incendio o de descarga eléctrica, este aparato no deberá verse expuesto a la lluvia ni a la humedad.



El símbolo de insulación Clase II (un cuadro dentro de otro cuadro) indica que este producto a sido evaluado y probado para cumplir con los requisitos de insulación Clase II.

Aviso de la FCC: Cualquier cambio o modificación a este receptor de TV no aprobado expresamente por Matsushita Electric Corporation of America podría provocar interferencia dañina, que nulificaría la autoridad del usuario para operar este equipo.

ADVERTENCIA: Como cualquier objeto pequeño, las tarjetas SD pueden ser tragadas por niños pequeños. No deje la tarjeta SD al alcance de los niños.

AVISO AMBIENTAL:

Este producto utiliza un tubo de rayos catódicos (TRC) así como otros componentes que contienen plomo. El desecho de estos materiales puede estar regulado en su comunidad debido a consideraciones ambientales. Para información de desecho o reciclaje contacte a sus autoridades locales, o a la alianza de industrias electrónicas: <[HTTP://WWW.EIAE.ORG](http://www.eiae.org)>



HDMI, el logo HDMI y la interfase multimedia de Alta Definición son marcas de fábrica o marcas registradas de HDMI Licensing LLC.



: El logo SD es una marca de fábrica

BBE[®] HD3D Sound

High Definition Sound

Bajo licencia de BBE Sound, Inc.

Bajo licencia de BBE Sound, Inc. Sobre el numero USP4638258, 4482866, 5510752 y 5736897.

BBE y el simbolo de BBE son marcas registradas de BBE Sound, Inc.

Este producto contiene tecnología de protección de derechos que esta protegida por patentes de los EEUU y otros derechos de propiedad intelectual. El uso de esta tecnología de protección de derechos debe ser autorizada por Macrovision Corporation, y es para uso en casa y otros casos limitados a menos que sea autorizado por Macrovision. La ingeniería reversible y desensamble estan prohibidas.

Patentes de los EEUU. 4,631,603; 4,577,216; 4,819,098; 4,907,093; 6,381,747; and 6,516,132.

Lea estas instrucciones completamente antes de operar la Televisión.

El contenido está sujeto a cambios sin previo aviso u obligación.

Derechos Reservados 2003 por Matsushita Electric Corporation of America.

Todos los Derechos Reservados. La copia y distribución sin autorización es violación de la ley.

Información Importante

Información sobre la Convergencia

En el televisor de proyección la imagen es formada al proyectar 3 imágenes de color distinto cada una (verde, rojo y azul) en la pantalla. **La convergencia se refiere a la alineación de las imágenes verde, roja y azul en la pantalla.** Cuando estas imágenes están alineadas correctamente (convergen), usted ve una imagen nítida y de colores vivos. Algunas veces las 3 imágenes requieren alineación. Esto se debe al efecto del campo magnético de la tierra en los tubos de proyección. Normalmente no se requiere de ajuste una vez que el ajuste inicial en el centro de la pantalla se ha llevado a cabo. Es posible corregir los bordes de color en otras áreas de la pantalla usando el control remoto y siguiendo las instrucciones en pantalla del menú de AJUSTE. Por favor ajuste la convergencia de las imágenes al usar el televisor por primera vez. El siguiente diagrama muestra ejemplos de una imagen mal ajustada y una imagen correctamente ajustada. **Favor de hacer referencia a las páginas 26 y 27 para el procedimiento en detalle de como ajustar la convergencia.**



Imagen con mala convergencia



Imagen correctamente ajustada

Nota: *Asegúrese de mantener el televisor encendido por al menos 20 minutos previo al ajuste de convergencia descritos en las páginas 26 y 27.*

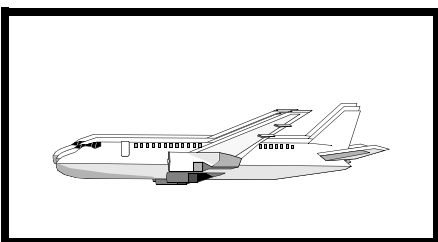
Información Importante Acerca Del Uso De Video Juegos, Computadoras, U Otros Tipos De Imágenes Fijas.

ADVERTENCIA: El marcado o retención de imagen en los tubos de proyección como resultado del uso de una imagen fija, no es un defecto de operación y como tal no está cubierto por la garantía.

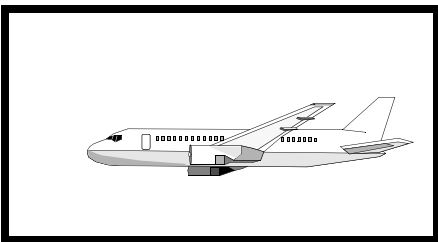
El sistema de proyección de video esta diseñado para desplegar imágenes en movimiento constante en la pantalla. El uso constante de imágenes fijas tal como películas en formato letterbox en pantallas estándar (con barras arriba y abajo de la imagen), películas estándar no expandidas (4:3) en TV's de pantalla ancha (con barras laterales visibles a cada lado de la imagen), barras de reporte de la bolsa mercantil (barra con información en movimiento en la parte inferior de la pantalla), patrones de video juegos, marcadores deportivos fijos, logos de estación televisora, patrones de internet u otros patrones de tipo computadora deben limitarse.

El uso extendido de material de imagen fija puede causar daño permanente a los tubos de proyección, el cual se presenta como 'imagen fantasma' visible en la imagen normal. Este tipo de desgaste irreversible de los tubos de proyección puede limitarse mediante los siguientes pasos:

- Limite el tiempo de uso de material de imagen fija a no más del 15% del tiempo de uso total a la semana.
- Apague la unidad cuando no se este usando.

Información de la FCC

Este equipo ha sido probado y cumple con el límite para un equipo digital clase B en acuerdo con las especificaciones en la parte 15 de las reglas de la FCC. Los límites se diseñan para proveer protección razonable contra interferencia de radio y televisión en una instalación residencial. Este equipo genera, utiliza y puede radiar energía de radiofrecuencia, y de no ser instalado y utilizado de acuerdo a las instrucciones, puede ocasionar interferencia nociva a comunicaciones de radio. Sin embargo, no existe garantía de que no ocurra interferencia en alguna instalación en particular.

Si este equipo causa interferencia a recepción de radio o televisión (la cual puede ser determinada al encender y apagar el equipo), intente corregir la interferencia con una o más de las siguientes medidas.

- Re-orienta o re-ubique la antena receptora.
- Incremente el espacio entre el equipo y el receptor.
- Conecte el equipo en un enchufe de c.a. al cual el receptor no se encuentre conectado.
- Consulte al Vendedor o un técnico experimentado en radio/TV.

Tabla de Contenido

Información Importante.....	1	Botón de Move	9
Información sobre la convergencia.....	1	Botones PIP MIN y PIP MAX	10
Información importante acerca del uso de video juegos, computadoras, y otros tipos de imágenes fijas	1	Botón de Freeze.....	10
Felicidades	3	Función de congelamiento de la imagen principal	10
Registro del usuario.....	3	Tabla operacional de los botones en modo IDI ó SPLIT	10
Cuidado y limpieza	3	Funciones Especiales de la Televisor de Proyección Alta Definición.....	11
Especificaciones	3	Botones Especiales del Control Remoto....	12
Tabla de características.....	3	Operación del Control Remoto	13
Instalación	4	Operación de componentes con el control remoto.....	14
Ubicación de la televisión	4	Programando el control remoto.....	16
Cables para la conexión por componentes	4	Programando sin código	16
Cable de suministro de corriente alterna	4	Códigos de componentes.....	16
Conexión de cable / antena	4	Navegación básica de menú.....	19
Programación inicial	4	Operación del Menús.....	20
Vista Frontal y Posterior del Televisor de Proyección de Alta Definición.....	5	Imagen	20
Conexiones de Equipo Opcional.....	6	Audio	20
Conexión de la videocasetera	6	Canales	21
Conexión del Módulo de Cable Digital.....	6	Operación del Photo Viewer™	22
Conexión del decodificador de televisión digital	6	Cronómetro	24
Panel de control frontal.....	6	Ajuste	25
Conexión de entrada HDMI	7	Bloqueo	28
Conexión de salida del Digital Audio Out	8	Glosario y Acrónimos.....	31
Conexión de salida del programa (PROG OUT)	8	Cuadro de Localización de Fallas	32
Conexión del amplificador de sonido (Analogo)	8	Índice.....	34
Operación de IDI y Pantalla de SPLIT	9		
Operación de IDI	9		
Operación de Split	9		
Operación de IDI y pantalla de SPLIT Botón.....	9		
Botón TV/VIDEO.....	9		
Botón de Search	9		

Nota: La Información acerca de la garantía y centro de servicio se encuentra al final de este manual.

Felicidades

Su nuevo Televisor de Proyección de Alta Definición (PTV) se caracteriza por utilizar lo último en tecnología en calidad de imagen y sonido, cuenta con conexiones completas de Audio y Video para su Sistema de Teatro en Casa. Su televisión está diseñada para brindarle muchos años de entretenimiento, fué sintonizada y comprobada en su totalidad en la fábrica para su mejor desempeño.

Registro del Usuario

El modelo y el número de serie de este producto se localizan en la parte posterior de este televisor. Deberá anotar el modelo y el número de serie en los espacios que se proveen a continuación y consérvelos permanentemente como comprobación de su compra. Esto le ayudará a identificarlo en caso de robo ó pérdida. Los consumidores en los Estados Unidos de América pueden registrar su producto en la siguiente dirección electrónica: www.prodreg.com/panasonic.

Número de
Modelo

Número de
Serie

Cuidado y Limpieza

Pantalla de Proyección (Apague el Televisor)

La pantalla de proyección es un sistema de lentes de alta precisión el cual contiene una pantalla protectora. La pantalla protectora es completamente lavable, con las siguientes precauciones:

- Use una solución de jabón o limpiador de vidrios y un paño limpio.
- NO UTILICE LIMPIADORES CORROSIVOS.
- No use detergente para lavar ropa ó jabón para lavaplatos automático.
- No use alcohol, amoníaco, o productos derivados del petróleo.
- Evite el exceso de humedad y frote hasta secar.
- Prevenga que la solución se derrame al interior del receptor.
- Evite golpear o rayar la pantalla.

Nota: Evite rociar cualquier tipo de limpiadores directamente sobre la pantalla.

Gabinete y Control Remoto

- Para gabinetes y control remoto use un paño humedecido con agua o una solución detergente suave. Evite el exceso de humedad y frote hasta secar.
- No use benceno, diluyentes u otros productos a base de petróleo.

Especificaciones

Las especificaciones están sujetas a cambio sin previo aviso ni obligación alguna.

Fuente de Potencia PT-47WXD63 (4,1A) PT-53WXD63 (4,1A) PT-53TWD63 (4,1A) PT-56TWD63 (4,1A)	120V CA, 60Hz
Capacidad de Canales ATSC/NTSC	VHF/UHF 2-69, Cable-1-125
Terminal de entrada HDMI	Tipo A
Terminales de Salida Audio Digital	Fibra óptica Dolby* digital
Componente Entrada de Video	75 Ohmios, Terminal tipo RCA
Terminales de Entrada de Video	1Vp-p, 75 Ohmios, Estilo RCA
Terminales de Entrada de Audio	500mV RMS 47Kilo Ohmios
Terminales de Salida de Video	1Vp-p, 75 Ohmios, Estilo RCA
Terminales de Salida de Audio	500mV RMS 4,7Kilo Ohmios
Terminales de Entrada S-Video	Conector S-Video (Y-C)

Tabla de Características

MODELOS	PT-47WXD63	PT-53WXD63	PT-53TWD64	PT-56TWD63
CARACTERISTICAS				
SINTONIZADOR DIGITAL ATSC	•	•	•	•
PHOTO VIEWER	•	•	•	•
MODULO DE CABLE DIGITAL (DCM)	•	•	•	•
IMAGEN EN IMAGEN CON 2 SINTONIZADORES	•	•	•	•
2RF	•	•	•	•
AJUSTE DE MAGNIFICACION (TAMAÑO Y POSICION)	•	•	•	•
PANTALLA PROTECTORA	•	•	•	•
SUBTITULOS	•	•	•	•
CAPACIDAD DEL V-CHIP	•	•	•	•
VELOCIDAD DEL BARRIDO DIGITAL	1080i 540p	1080i 540p	1080i 540p	1080i 540p
DOBLADOR DE LINEAS NTSC	540p	540p	540p	540p
VIDEO NORM	•	•	•	•
AUDIO NORM	•	•	•	•
ESTEREO	•	•	•	•
SONIDO IA	•	•	•	•
BAJOS/BALANCE/AGUDOS	•	•	•	•
SONIDO ENVOLVENTE	•	•	•	•
BBE VIVA 3D			•	•
BBE	•	•	•	•
ENTRADA HDMI/HDCP	•	•	•	•
ENTRADA A/V (POSTERIOR/DELANTERA)	4 (3/1)	4 (3/1)	4 (3/1)	4 (3/1)
SALIDA AUDIO DIGITAL	•	•	•	•
ENTRADA S-VHS	•	•	•	•
ENTRADAS DE VIDEO POR COMPONENTE	•	•	•	•

*Fabricado bajo autorización de Laboratorios Dolby. "Dolby" y el símbolo doble-D son marcas registradas de los Laboratorios Dolby.

Instalación

Ubicación de la Televisión

Esta unidad tiene como propósito ser usada como parte de un centro de entretenimiento. Consulte a su distribuidor para obtener opciones disponibles.

- Evite el exceso de luz solar u otras luces brillantes, incluyendo reflejos.
- Mantenga alejada la unidad del exceso de calor o humedad. La ventilación inadecuada puede causar fallas en componentes internos.
- La iluminación fluorescente puede reducir el rango de transmisión del control remoto.
- Evite el equipo magnético, incluyendo motores, ventiladores o altavoces externos.

Cables para la conexión por componentes

Cables blindados de audio y video deben usarse entre los componentes. Para obtener mejores resultados:

- Use cable coaxial blindado de 75 ohmios.
- Use los conectores de entrada y salida apropiados, iguales a los de su componente.
- Evite el uso de cables largos para minimizar interferencia.

Cable de Suministro de Corriente Alterna

PRECAUCION: PARA PREVENIR UNA DESCARGA ELECTRICA, BUSQUE LA CLAVIJA ANCHA DEL ENCHUFE E INSERTELA POR COMPLETO EN LA RENDIJA ANCHA DE LA TOMA DE CORRIENTE ALTERNA. NO USE ESTE ENCHUFE CON UN RECEPTACULO U OTRA TOMA DE CORRIENTE SALVO QUE LA CLAVIJA SE PUEDA INSERTAR POR COMPLETO PREVINIENDO QUE SE EXPONGA LA CLAVIJA.



Enchufe polarizado

PROTEJA EL CABLE DE AC DE SER PISADO, ENROLLADO, PLEGADO, TROZADO O PERFORADO, PARTICULARMENTE EN LOS CONECTORES Y EN LOS PUNTOS DONDE SALE DEL APARATO.

Conexión de Cable / Antena

Para una recepción adecuada, se requiere una conexión de cable o de antena.

Cable de Entrada de la Compañía de Cable

Conexión de cable

Conecte el cable suministrado por su compañía local de cable a la conexión ANT A en la parte posterior de la televisión. Seleccione la modalidad de Cable en el menú Setup bajo Program CH.

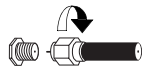

75 Ohmios VHF/UHF en la parte posterior de la TV

Conexión de Antena

- Para una recepción adecuada de canales VHF/UHF, se requiere de una antena externa. Para la mejor recepción, se recomienda una antena en el exterior.
- Conecte el cable de la antena a la conexión ANT A en la parte posterior de la televisión. Seleccione la modalidad de Antenna en el menú Input Setup bajo Program CH en el menú Setup.

Cable de Entrada de una Antena de Casa

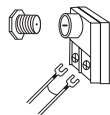

Nota: La Modalidad de Cable está predispuesta de fábrica. Usuarios de antena deberán cambiar a modalidad de Antena en el menú de Setup. *Si tiene cable y antena, el cable debe ser conectado al conector ANT A.*

First Time Setup (Programación Inicial)

Para su conveniencia, el menú de auto programación será desplegado en pantalla cuando el set sea encendido por primera vez. De ser necesario, siga los menús y los procedimientos para ajustar las características.

Programación de la entrada de RF

Para seleccionar la modalidad de TV (antena) o CABLE dependiendo de la fuente de la señal.

Procedimiento

- Press **VOL** ► para seleccionar Cable only, Cable/Antenna ó Antenna only.
- Presione el botón de **OK** para subrayar su selección.

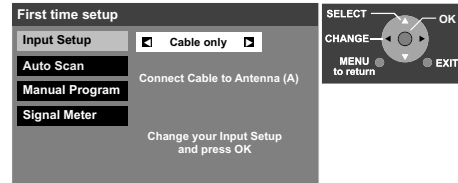

- Cuando la siguiente pantalla es desplegada, presione **OK** para iniciar la auto búsqueda. Todos los canales disponibles serán programados en memoria.

Auto Scan (BUSQUEDA AUTOMATICA)

Para programar automáticamente todos los canales con señal.

Procedimiento

- Presione **OK** para programar automáticamente todos los canales con señal.

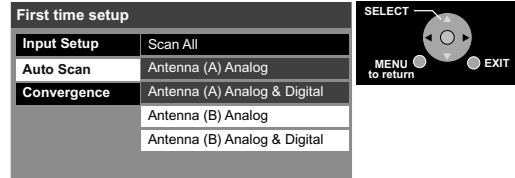

- Una vez terminada la programación, el televisor sintonizará el primer canal encontrado durante la búsqueda automática.

Notas:

- Si el botón EXIT es presionado en cualquier momento durante la búsqueda, el menú de Programación Inicial será cancelado y el televisor sintonizará el canal 2 análogo en la ANTENNA (A).
- Si el POD esta conectado durante la Programación Inicial y Antenna (A) esta en Cable, la Antenna (A) no será buscada ya que el POD proveera el mapa de canales.

Convergence (Convergencia)

Este menú le permite ajustar la alineación del TRC verde y la convergencia del centro. Siga las instrucciones en pantalla para realizar el ajuste de convergencia. Una vez hecho el ajuste de convergencia presione **EXIT** para salir del menú.



Vista Frontal y Posterior del Televisor de Proyección de Alta Definición

Panel de control frontal (PT-47WXD63 y PT-53WXD63)

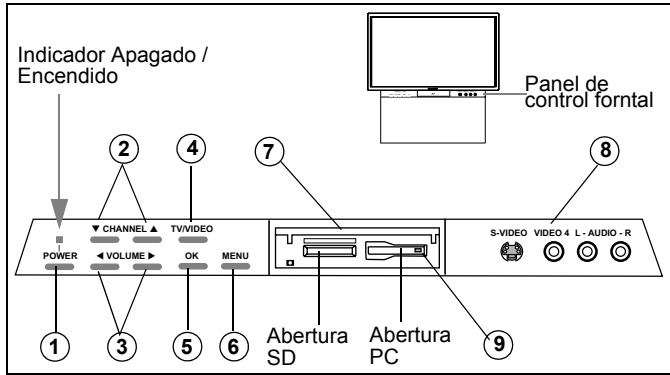

Panel de control frontal (PT-53TWD63 y PT-56TWD63)

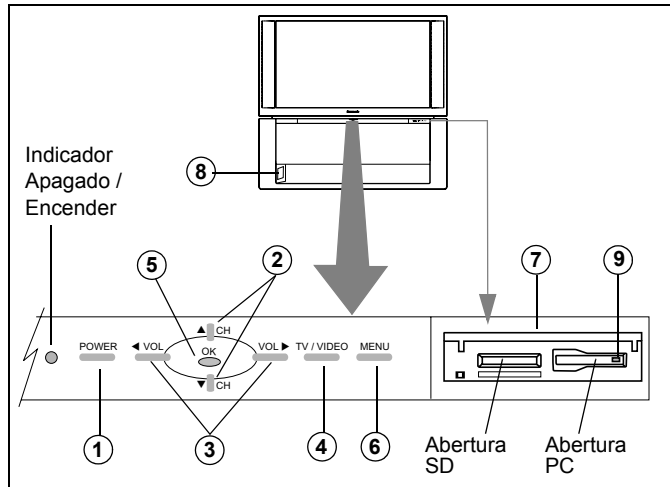

Botón	Descripción
① POWER	Apagado/Encendido
② ▼CH and CH▲	Selecciona canal siguiente o previo, navegación arriba/abajo en los menús.
③ ◀VOL and VOL▶	Aumenta o disminuye el volumen, navega izquierda/derecha en los menús, ajusta la función seleccionada en el menú.
④ TV/VIDEO	Selecciona la señal de entrada.
⑤ OK	Confirma el canal seleccionado, presione para aceptar la elección del menú o sub-menú.
⑥ MENU	Muestra o elimina el menú o regresa un nivel en los menús.
⑦ Photo Viewer™	Le permite ver las imágenes JPEG grabadas en las tarjetas de memoria de una cámara digital.
⑧ VIDEO 4	Entradas análogas para aparatos externos.
⑨ Botón Eject	Presione este botón para expulsar la tarjeta de memoria.

Panel de conectores posteriores

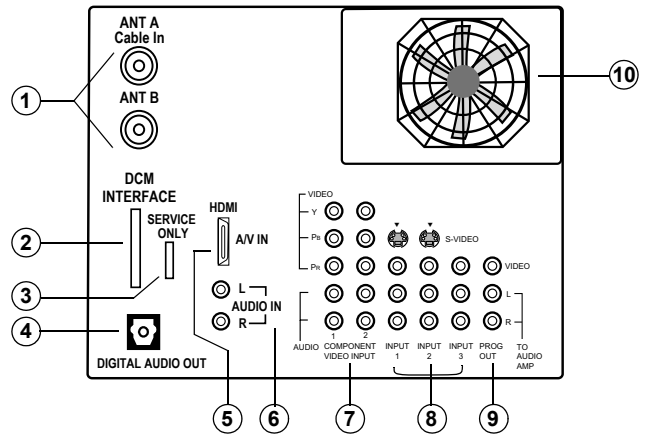

Referencia	Descripción
①	Entradas de antena ANT A - Conecte una antena terrestre o de cable a esta entrada para recibir canales digitales. ANT B - Si tiene ambas antenas, terrestre y cable, conecte la antena terrestre a ANT B.
②	DCM INTERFACE (POD INTERFACE) Introduzca el módulo POD (o DCM: Módulo de Cable Digital) de la compañía de cable para recibir servicio digital "premium".
③	SERVICE ONLY Conector usado por el técnico de servicio para actualizar el programa.
④	DIGITAL AUDIO OUT Salida óptica de sonido envolvente Dolby Digital 5.1.
⑤	HDMI (Interfase Multimedia de Alta Definición) Entrada que acepta señal digital sin comprimir y señal de audio digital multicanal.
⑥	AUDIO IN Use estos conectores de audio cuando aparatos con DVI son conectados al conector HDMI usando el adaptador DVI a HDMI.
⑦	COMPONENT VIDEO (Y-P_B-P_R) INPUTS Use estos conectores para conectar aparatos como un reproductor de DVD o un Set Top Box.
⑧	INPUTS 1, 2 y 3 Entradas Compuestas para conectar una videocasetera u otros aparatos.
⑨	PROG OUT Conectores de salida de audio fijo y video compuesto.
⑩	Abanico de enfriamiento

*Las descripciones en el panel de conectores posterior pueden cambiar sin previo aviso.

Conexiones de Equipo Opcional

Nota: El control remoto debe de ser programando con los códigos suministrados para operar equipo opcional.

Conexión de la Videocasetera

Siga este diagrama cuando conecte en su televisión, solamente la videocasetera.

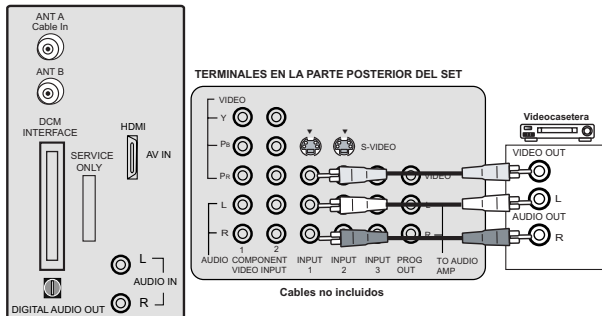

Para ver un vídeo

Procedimiento

- Presione el botón de **TV/VIDEO** en el control remoto para seleccionar la entrada de vídeo (VIDEO 1, VIDEO 2, etc.) que está conectada a su videocasetera.
- Comience el vídeo.

Conexión del Módulo de Cable Digital

Este módulo le permite sintonizar canales digitales y de alta definición a través de su antena de cable. Consulte a su compañía de cable para la disponibilidad de este módulo (también llamado módulo POD).

Nota: Una suscripción a cable digital es requerida. (refierase a la página 27)

Procedimiento

- Conecte la antena del cable al conector **ANT A/Cable In** en la parte posterior del set.
- Inserte el módulo DCM al conector DCM INTERFACE (POD INTERFACE) en la parte posterior del set.

Notas:

- El lado izquierdo equivale a la parte superior del módulo POD.
- No introduzca una tarjeta PCMCIA en el conector DCM INTERFACE (POD INTERFACE).
- Seleccione el modo de Cable en Antenna (A) en el menú Input Setup.
- Siga las instrucciones en pantalla

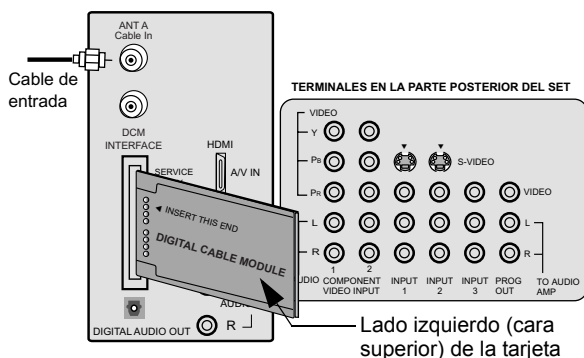

Nota: Si los botones del panel de control frontal o del control remoto dejar de funcionar cuando utiliza el módulo de cable digital (DCM), desconecte el cable de CA del televisor, vuelvalo a conectar y pruebe de nuevo. Si el problema persiste, consulte al Centro de Atención a Clientes de Panasonic.

Conexión del Decodificador de Televisión Digital (DTV-STB) ó DVD

Esta televisión tiene la capacidad de proyectar imágenes en formato 1080i, 480p y 480i Televisión Digital (DTV) utilizando un receptor-decodificador (STB). Para ver programación de Televisión Digital, el STB debe estar conectado a las entradas de vídeo compuesto (Y, P_B, P_R) de la televisión. Debe haber una señal de DTV disponible en su área. Seleccione el formato del STB a 1080i o 480p.

Esta TV utiliza un doblador de barrido progresivo, el cual barre la imagen de formato NTSC de manera progresiva. Esto le permite no ver las delgadas líneas negras (efecto de persiana) que va relacionado con la imágenes entrelazadas.

Utilice este diagrama para conectar el decodificador de Televisión Digital Panasonic (DTV-STB) ó DVD a su Televisor.

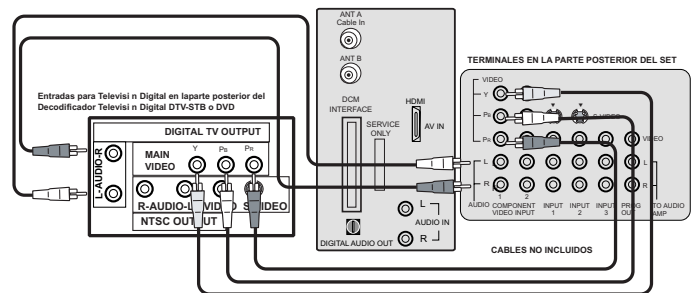

El televisor tiene dos grupos de entradas de vídeo compuesto, cada grupo tiene tres entradas: Y, P_B y P_R. Las entradas separadas para las señales compuestas de color, proveen una mejor separación de luminancia y color.

Panel de Control Frontal

El panel de control frontal puede ser usado para acceder el menú ó cambiar el modo de vídeo cuando no se disponga del control remoto.

El indicador de APAGADO/ENCENDIDO (rojo) estará prendido cuando esté encendido.

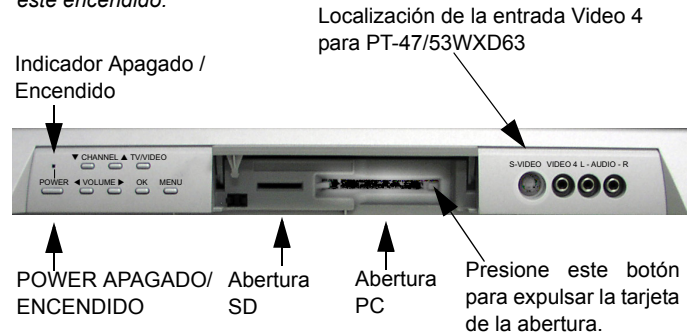

Abra la puerta del panel frontal de la PTV para usar estas conexiones para su equipo opcional (videocámara, VCR u otros componentes de vídeo). Seleccione el modo de entrada vídeo 4 presionando el botón TV/VIDEO.

Procedimiento

- Conecte su equipo a las conexiones Audio/Vídeo en la parte frontal o posterior de la televisión.
- Presione TV/VIDEO para seleccionar la entrada de VIDEO 4.
- Opere el equipo como se instruye en el manual del equipo.

Conexión de entrada HDMI

Sobre HDMI

HDMI es la primera interfase de A/V para electrónica de consumidor completamente digital que soporta todos los formatos de video estándar, mejorados y de alta definición así como todos los formatos de audio multicanal existentes. Un conector soporta la información de video y de audio. La entrada HDMI/HDCP¹ puede ser conectada a un dispositivo que cumpla con la norma EIA/CEA 861², tal como un set top box o reproductor de DVD equipado con un conector de salida HDMI o DVI. Al conectar una fuente de imagen de alta definición con protección digital de copia con alto ancho de banda (HDCP) a la terminal HDMI de esta unidad, podrá ver en pantalla imágenes de alta definición en su forma digital. La terminal de entrada HDMI no es para conectarse con una computadora personal. Este PTV es compatible con los formatos 1080i, 480p y 480i. Seleccione la salida del dispositivo conectado a uno de estos formatos.

Notas:

1. HDMI/HDCP = Interfase Multimedia de Alta Definición / Protección Digital de Copia con Alto Ancho de Banda.
2. Los perfiles EIA/CEA-861 cubre perfiles para la transmisión de video digital sin compresión incluyendo contenido digital de protección de alto ancho de banda.

Formatos compatible

Este PTV es compatible con los siguientes formatos. Ajuste el aparato conectado a uno de los siguientes formatos.

Señal de video

Formato	Número de puntos	Frecuencia de barrido vertical (Hz)
1080i	1920 x 1080i	59.94 / 60
540p (480p)	720 x 480p 640 x 480p	59.94 / 60 59.94 / 60
540p (480i)	720 x 480i	59.94 / 60

Señal de Audio

Cuando audio digital es incluido en la conexión HDMI, las frecuencias compatibles son 48 KHz / 44.1Khz / 32 KHz.

Diagrama de conexión

Siga el diagrama mostrado en la parte inferior para conectar el PTV a un set top box o a un reproductor de DVD.

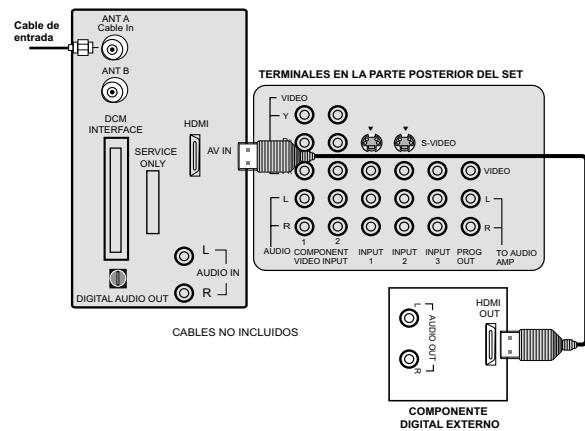

Procedimiento

- Presione el botón TV/VIDEO en el control remoto para seleccionar la entrada HDMI. El conector en este PTV es HDMI tipo A.
- Conecte la salida HDMI del set top box o reproductor de DVD a la entrada HDMI IN en la parte posterior del PTV.
- Si el dispositivo externo solo tiene salida DVI, utilice un adaptador*³ de DVI a HDMI para conectarse al conector HDMI en el PTV. Además, conecte la señal de salida de audio del dispositivo externo (set top box o reproductor de DVD) a los conectores de Audio In*⁴ localizados abajo del conector HDMI.
- Si no puede ver la imagen por que su Set Top Box no tiene una terminal de salida digital, use la entrada de video por componentes (o el conector de S-Video o Video). En este caso, la imagen vista será de señal análoga.

Notas:

- *3. El cable convertidor HDMI-DVI (TY-SCH03DH) está disponible en la página de internet de Panasonic: www.panasonic.com.
- *4. Vea las páginas 20 y 21 para los detalles de ajuste de audio.

Digital Audio Out Connection (Conexión de salida de audio digital)

Utilice el diagrama mostrado en la parte inferior para conectar la salida de audio digital de su Televisor de Proyección HDTV a un decodificador Dolby Digital.

Digital Audio Out (Salida de audio digital)

El sonido envolvente Dolby Digital de 5.1 canales le permite tener sonido de calidad digital. Dolby Digital provee cinco canales discretos de ancho de banda completo para frontal izquierdo, frontal derecho, centro, envolvente izquierdo y envolvente derecho, más un canal de sub-graves LFE (Efecto de Baja Frecuencia). Para una disfrutar de un sonido de teatro en casa completo, un decodificador Dolby Digital externo y un amplificador multicanal deben ser conectados al conector Digital Audio Out de su PTV.

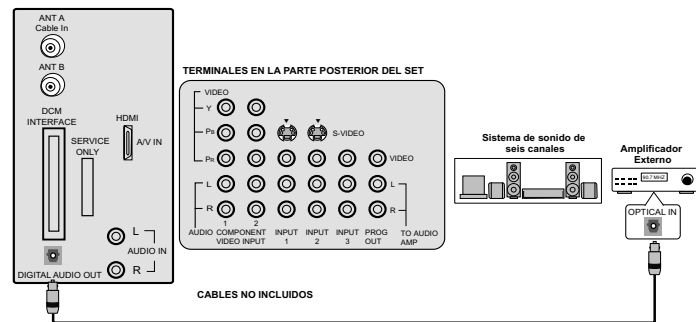

Procedimiento

- Conecte el cable digital de audio del conector Digital Audio Out de su PTV al conector Digital Audio In de su decodificador Dolby Digital.

Nota: Cuando un canal ATSC es seleccionado, la salida del conector Digital Audio Out será Dolby Digital. Pero si el canal seleccionado es NTSC, la salida será PCM.

Conexión de Salida del Programa (PROG OUT)

Para visualizar en la Televisión el video y el audio con una videocasetera. Un monitor externo también puede ser conectado a las terminales de PROG OUT y TO AUDIO AMP. Connect the VCR as shown below.

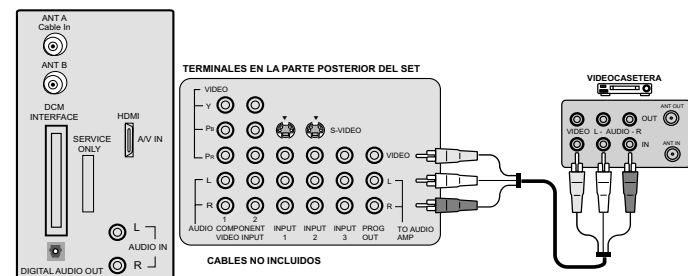

Procedimiento

- Conecte la videocasetera a las terminales PROG OUT y TO AUDIO AMP R/L.
- El despliegado de terminal PROG OUT es el mismo que el despliegado en pantalla.
- Véase el manual de equipo opcional para instrucciones acerca del grabado.

Notas:

- Este PTV contiene salidas de video y audio con el propósito de grabar programación de la televisión a una videocasetera. Debido a las restricciones de licencias, si un aparato (STB, DVD, etc.) es conectado al conector HDMI del PTV, la salida de audio y video no es permitida.
- La señal de Program Out no estará disponible cuando la imagen principal sea de la entrada por componentes.
- La señal Program Out estará disponible cuando reciba un canal digital. Pero todos los formatos digitales serán convertidos a video NTSC compuesto.
- Cuando reciba una canal digitales o análogos y los subtítulos análogos o digitales estén activados, la salida del conector de Program Out tendrá subtítulos en la imagen de video. Si los subtítulos están desactivados, solo información de subtítulos análogos será transferida.
- Algunas salidas de contenido de programa de los conectores de Program Out pueden contener señal de Macrovision, previniendo así que una videocasetera puede grabar esta señal.

Conexión del Amplificador de Sonido (Analogo)

Conecte a la entrada de audio de un amplificador externo para escuchar el sonido en sistema estéreo.

Nota: Las terminales TO AUDIO AMP no pueden ser usadas directamente para bocinas externas.

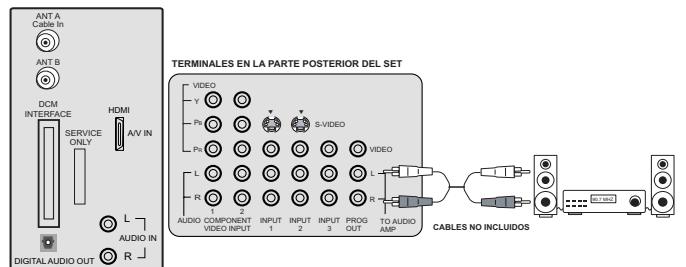

Ajustes de Sonido (Audio)

- Seleccione ALTAVOCES Off en el menú de SONIDO (AUDIO).
- Ajuste el volumen del amplificador al nivel deseado.

Operación de IDI y Pantalla de SPLIT

Operación de IDI

Esta Televisión incluye una característica de sintonizador dual para Imagen en Imagen (IDI). Esto permite ver dos (2) canales en vivo al mismo tiempo, ya sea con o sin una fuente de vídeo externa (VCR).

Nota: Solo la programación análoga de la Antena (A) y las entradas de video pueden ser vistas en el Marco IDI /SPLIT.

Procedimiento

- Conecte el cable de la antena a la entrada ANT A en la parte posterior de televisor.

- Presione para desplegar el marco IDI.
- Presione los botones mientras el marco IDI esta desplegado para seleccionar los canales.

IDI esta desplegado para seleccionar los canales.

- Escoja canales para la Imagen Principal presionando or CH o usando el teclado numérico.

- Presione para intercambiar la imagen principal con la imagen dentro del marco IDI.

- Presione para ver la información de fuentes de ambos imágenes

- Presione para cancelar IDI marco.

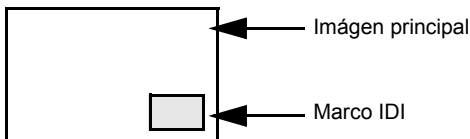

Nota: El Audio es sólo de la Imagen Principal.

Operación de SPLIT

Esta función permite ver 2 canales diferentes, uno al lado del otro, con o sin una fuente de video externa. El audio es de la imagen principal unicamente (lado izquierdo).

Procedimiento

- Presione para desplegar la imagen SPLIT.
- Escoja canales para la Imagen SPLIT presionando

- Escoja canales para la Imagen Principal presionando or CH o usando el teclado numérico.

- Presione para intercambiar la Imagen SPLIT con la Imagen Principal derecha.

- Presione to para verla información imágenes.

- Presione para cancelar la pantalla Split.

Nota: La IDI o SPLIT no pueden mostrar un canal digital. Puede ver el canal digital como la imagen principal y un canal análogo en la IDI ó SPLIT, ó canales análogos en ambos. La función SWAP funciona sólo cuando la imagen principal y la IDI ó SPLIT son canales análogos o señal de entrada de video.

Operación de IDI y Pantalla de SPLIT Botón

Botón TV/VIDEO

Presione cuando la IDI o el Split están desplegados para seleccionar la entra de video deseada.

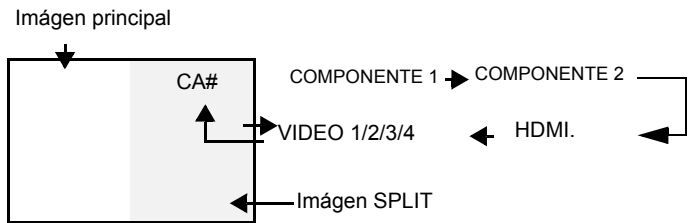
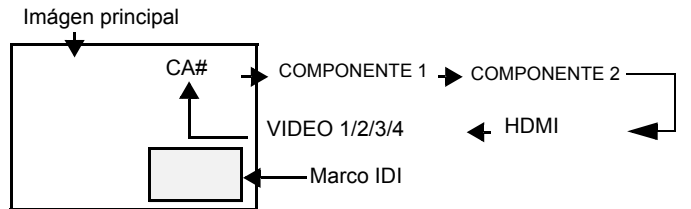

Botón Search (IDI y Split)

Esta función permite hacer una búsqueda de todos los canales análogos disponibles.

- Presione el botón o para desplegar el marco de la IDI o la pantalla Split.

- Presione para desplegar los marcos de búsqueda.

Nota: Cuando la imagen principal es digital ATSC, la búsqueda no es posible. La caraterística de búsqueda solo funciona con canales análogos.

- Presione **SEARCH** botón de nuevo para detener la función de búsqueda. El canal de la IDI ó Split será el último marco activo.

- Presione o para cancelar el marco de la IDI o Split.

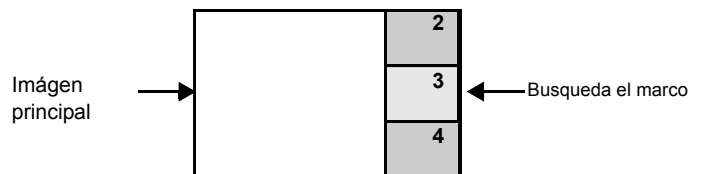

Botón Move (sólo IDI)

Esta función es utilizada para mover el marco de la IDI a una de las cuatro esquinas.

Procedimiento

- Presione para desplegar el marco de la IDI.

- Presione **MOVE** para posicionar el marco de la IDI en la esquina deseada.
- Presione **PIP** para cancelar IDI marco.

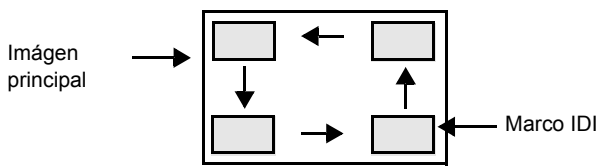

Botões PIP MIN y PIP MAX

Cuando el marco de la IDI es desplegado, presione el botón PIP MIN ó PIP MAX para variar el tamaño del marco.

Procedimiento

- Presione **PIP** para desplegar el marco de la IDI.
- Presione **PIP MIN** o **PIP MIN** para ajustar el tamaño del marco.
- Presione **PIP** para cancelar IDI marco.

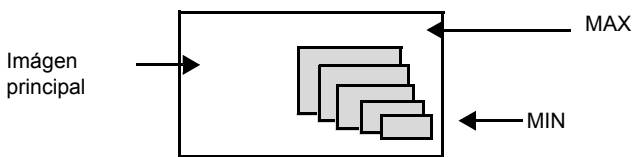

Botón Freeze (IDI y Split)

Esta función es utilizada para congelar la imagen en la IDI o Split.

Procedimiento

- Presione **PIP** o **SPLIT** para desplegar el marco de la IDI Split.
- Presione **FREEZE TV/VCR** de nuevo para descongelar la imagen.
- Presione **FREEZE TV/VCR** de nuevo para descongelar la imagen.
- Presione **PIP** ó **SPLIT** para cancelar el marco de la IDI ó Split.

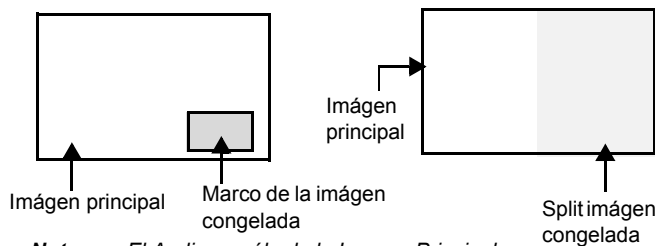

Nota: El Audio es sólo de la Imagen Principal.

Función de congelamiento de imagen principal

Esta función se usa para congelar la imagen principal y desplegarla in la IDI o en SPLIT.

Procedimiento

- Para congelar la imagen principal, presione **FREEZE TV/VCR** mientras la IDI o SPLIT no estén desplegados.
- La imagen principal congelada aparecera en la IDI o en SPLIT, dependiendo de la opción seleccionada en el menu FREEZE localizado dentro de Imagen Otros AJ. (referirse a la pagina 20).
- presione **FREEZE TV/VCR** nuevamente para cancelar la congelación de imagen.

Nota: Mientras la imagen congelada este desplegada, solo el boton MOVE esta activo para IDI, cualquier otro botón para IDI o SPLIT no tendra efecto (ver tabla).

Tabla operacional de los botones en modo IDI ó SPLIT

Esta tabla muestra los botones que están activos cuando se encuentra en modo IDI ó SPLIT.

Botónes	MODO IDI	MODO SPLIT	MODO IMAGEN PRINCIPAL
PIP MIN	Tamaño pequeño	No funciona	No funciona
PIP MAX	Tamaño grande	No funciona	No funciona
FREEZE	Congela marcos IDI	Congela marcos IDI	Desplegar o Suprimir
PIP CH	Cambiar Canales de IDI	Cambiar Canales de SPLIT	No funciona
SEARCH	Desplegar marcos de búsqueda (no disponible cuando la imagen principal es digital)	Desplegar marcos de búsqueda (no disponible cuando la imagen principal es digital)	No funciona
PIP	Suprimir marcos de IDI	Desplegar marcos de IDI	No funciona
SPLIT	Desplegar marcos de SPLIT	Suprimir marcos de SPLIT	No funciona
MOVE	Mueve marcos IDI	No funciona	Mueve marcos IDI
SWAP	Intercambiar con imagen principal (no disponible cuando la imagen principal es un canal digital)	Intercambiar con imagen principal (no disponible cuando la imagen principal es un canal digital)	No funciona

Funciones especiales del Televisor de Proyección de Alta Definición

Sintonización de canales y programas

La sintonización de canales y programas en televisión digital es distinta de la televisión actual. En DTV (Televisión Digital), hasta seis (6) programas múltiples pueden existir en un solo canal de 6MHz. Estos canales se comportan como sub-canales dentro de un solo canal. Cuando sintonice un canal digital, el televisor de proyección de alta definición también sintonizará un programa. El televisor de proyección de alta definición le indicará el canal y el programa por medio de la barra de información del canal.

Nota: Para seleccionar canales adecuadamente, debe de llevarse a cabo la auto programación (ver página 25).

Sintonizando canales digitales y análogos

Puede sintonizar los canales digitales y análogos de las siguientes maneras:

- Sintonización directa (botones 0 - 9) - usando el teclado numérico del control remoto para introducir el número de canal directamente. Si es necesario, use el botón \ominus para introducir el número de programa del canal digital.
- Canal arriba/abajo (botón CH \blacktriangle o CH \blacktriangledown) - Sintoniza el canal o programa siguiente o previo. Esta manera depende del modo de sintonización (ver pág. 21) que seleccione en el menú Channel.
- Sintonización rápida (R-TUNE) - Cambia entre los dos últimos canales o programas.

Método de sintonización directa

Siga el procedimiento de abajo para introducir el directamente el número de canal utilizando el teclado numérico del control remoto.

Procedimiento

- Presione los botones del teclado numérico del control remoto para introducir el número del canal. Presione **OK**.
- Si desea sintonizar un canal digital y su canal contiene más de un programa, presione el botón \ominus e introduzca el número del programa (1, 2, 3 etc.) usando el teclado numérico. Presione **OK**. El siguiente es un ejemplo de como sintonizar el canal 15-1.

Ejemplo de sintonización directa

Paso	Acción	Barra de información de canal
1	Presione 1	1
2	Presione 5	15
3	Presione \ominus	15-
4	Presione 1	15-1
5	Presione OK	15-1

El televisor de proyección de alta definición sintonizará el canal 15-1.

Barra de información de canal: minimizada

La barra de información de canal minimizada mostrará la antena utilizada, el número de canal, y la identificación de la estación (si esta disponible).



Barra de información de canal: maximizada

Presione **RECALL** para mostrar la barra de información de canal maximizada. Mientras la barra de información de canal esta desplegada, puede adicionar o remover el canal a la lista de canales favoritos.

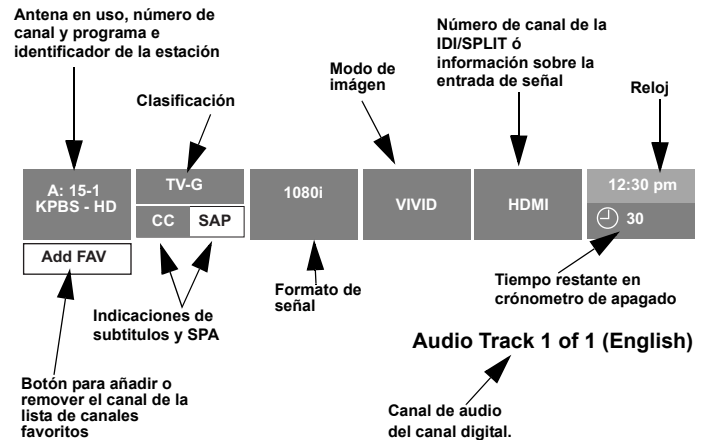

Función de agregar / remover Favoritos

Esta función le permite agregar o remover canales a la lista de canales favoritos.

Procedimiento

- Sintonice el canal deseado.
- Presione **RECALL** para mostrar la barra de información de canal.
- Presione **OK** ejecutar su selección.

Sintonización forzada por el Sistema de Alerta de Emergencia (EAS)

Si tiene un módulo POD instalado, el sistema múltiple de dueño/operador de cable (MSO) podría proveer un mensaje del sistema de alerta de emergencia. Estos mensajes son para informar al público en general de situaciones de emergencia locales o nacionales de importancia. En caso de recibir uno de estos mensajes, el televisor de proyección de alta definición sintonizará inmediatamente el canal con el mensaje EAS. Si el canal a sido bloqueado usando el control de bloqueo del televisor, este control tiene prioridad sobre la sintonización forzada.

Botones especiales del control remoto

Botón ASPECT

Opciones de despliegue de imagen según la señal de entrada

Señal de entrada	Formato en pantalla	Opciones para botón ASPECT
1080i	Solo 16:9	Sin opción
480p (16:9)	Default a 16:9	4:3, Comp o Acerc (Ver sig. columna)
480p (4:3)	Default a modo COMP. <i>Nota: La imagen es estimada Horizontalmente.</i>	4:3, Comp o Acerc (Ver sig. columna)
480i	Default a modo JUSTO	4:3, Comp, Justo o Acerc (Ver sig. columna)

El botón **ASPECT** le permite seleccionar uno de los cuatro modos de imagen, dependiendo del formato de la señal recibida y preferencias personales. El botón **ASPECT** le permite seleccionar uno de los cuatro modos de imagen, dependiendo del formato de la señal recibida y preferencias personales.

Señal de entrada	ASPECT	Imagen en formato 16:9
480i o 480p	4:3 →	

Esta opción despliega una imagen 4:3 a su tamaño estándar 4:3 con barras laterales gris. No es recomendado para ver imágenes 4:3, puede causar imagen permanente en la pantalla.

Señal de entrada	ASPECT	Imagen en formato 16:9
480i o 480p	ACERC →	

Amplia la imagen 4:3 uniformemente (ancho y alto).

Nota: Si el menú es desplegado mientras en modo Zoom, el aspecto cambiará a modo Comp para desplegar el menú completo.

Señal de entrada	ASPECT	Imagen en formato 16:9
480i o 480p	COMP →	

Esta opción despliega una imagen en pantalla completa. (recomendada para imágenes Anamórficas).

Señal de entrada	ASPECT	Imagen en formato 16:9
480i	JUSTO →	

Esta opción estira la parte izquierda y derecha de una imagen 4:3 al tamaño de pantalla. El centro de la pantalla tendrá corrección de aspecto. El tamaño de la imagen depende del tamaño original. (recomendado para uso normal.)

Botón BBE

Presione este botón para activar la función BBE VIVA 3D (disponible solo para PT-53TWD63 o PT-56TWD63) o BBE (disponible solo para PT-47WXD63 o PT-53WXD63).

Botón SAP

Presione este botón para seleccionar el siguiente canal de audio (si esta disponible) cuando reciba una canal digital.

Audio Track 1 of 1 (English)

En modo análogo, presione este botón para seleccionar entre los distintos modos de audio. Por ejemplo:

- Si recibe STEREO, SAP y MONO o recibe STEREO y MONO solamente, al presionar el botón SAP, el audio cambiará de la siguiente manera:

▶ STEREO → SAP → MONO ◀

Botón PROG

Quando sintonize un canal digital, presione el botón **PROG** para introducir el número menor en un canal de número compuesto.

Botón MENU

Presione para mostrar el menú principal o para regresar un paso en el menú.

Botón RECALL

Presione este botón para mostrar o quitar el encabezado de canales. Mientras el encabezado este desplegado, usted puede agregar o quitar canales a su lista de canales favoritos.

Botón R-TUNE

Press to switch to previously viewed channel, Photo Viewer or input modes.

Operación del Control Remoto

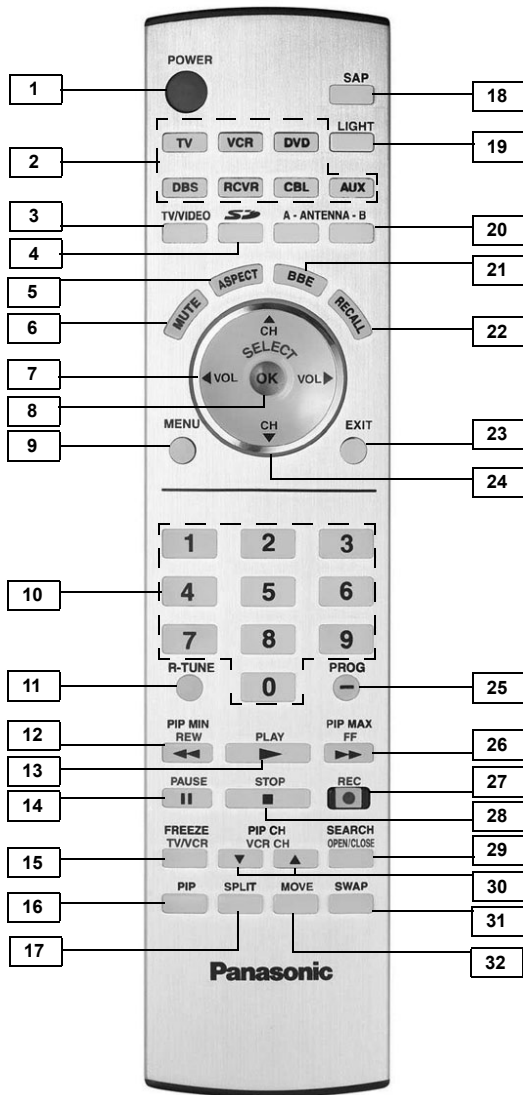

NUMERO DE BOTON	DESCRIPCIÓN
1	Presione para ENCENDER o APAGAR <i>Nota: El indicador ON/OFF estará encendido (rojo) cuando el set este encendido.</i>
2	Presione para seleccionar el modo del control remoto.
3	Presione para seleccionar la modalidad de televisión o video.
4	Presione para acceder al Photo Viewer. Dentro del Photo Viewer presione para acceder el menú del Photo Viewer.
5	Seleccione el tamaño de la imagen (aspecto) para igualarlo al formato de la programación. Dentro del Photo Viewer para cambiar el aspecto de la imagen en pantalla.
6	Presione para silenciar el sonido. Presione para mostrar y remover el CC (Closed Caption).
7	Presione para ajustar el nivel del audio de la TV y navegar en los menús.
8	Presione para entrar al menú.

NUMERO DE BOTON	DESCRIPCIÓN
9	Presione para mostrar el menú principal o regresar un paso en los menús.
10	Presione el teclado numérico para seleccionar cualquier canal o introducir caracteres alfanuméricos en los menús.
11	Presione para regresar al canal previamente visto o modo de video.
12	PIP MIN - En modo TV, presione para reducir el tamaño del marco IDI. REW - En modo VCR o DVD, presione para regresar.
13	En modo VCR o DVD, presione para tocar.
14	En modo VCR o DVD, presione para pausar.
15	FREEZE - En modo TV, presione para congelar la imagen en el marco IDI o SPLIT. TV/VCR - Presione para seleccionar entre modo TV o VCR en su videocasetera.
16	Presione para desplegar o cancelar el marco IDI.
17	Presione para desplegar o cancelar la pantalla SPLIT.
18	Presione para acceder los modos de audio (Stereo, SAP o Mono).
19	Presione para iluminar los bones del control remoto.
20	Presione para seleccionar la entrada de antena de RF (A o B).
21	Presione para encender o apagar.
22	Presione para desplegar o cancelar la información de canal.
23	Presione para salir del menú.
24	Presione para seleccionar el siguiente canal y navegar en los menús.
25	Presione para delimitar entre los canales mayores y menores.
26	PIP MAX - Presione el botón para incrementar el tamaño del marco IDI. FF - En modo VCR o DVD, presione para adelantar.
27	En modo VCR, presione para grabar.
28	En modo VCR o DVD, presione para detener.
29	SEARCH - Presione para explorar todos los canales disponibles en los marcos de búsqueda. Presione de nuevo para detener la función de búsqueda. OPEN/CLOSE - Presione para abrir o cerrar la bandeja del reproductor de DVD.
30	Presione para cambiar canales el IDI o la videocasetera.
31	Presione para intercambiar la imagen IDI/SPLIT con la imagen Principal.
32	Esta función es utilizada para mover el marco de la IDI a una de las cuatro esquinas.

Instalación de Pilas en el Control Remoto

Use dos pilas AA:

Quite la tapa del compartimento de pilas presionando en dirección a la flecha. Instale las pilas igualando las marcas (+) y (-) de la polaridad. Coloque nuevamente la tapa de las pilas.

Precauciones

Reemplace las pilas por pares. No mezcle tipos de pilas (carbono de zinc con alcalina). No intente cargar, hacer, cortocircuito, desarmar, calentar o quemar las pilas.

Operación de Componentes con el control remoto

Nota: Refierase a la página 16 para procedimientos de programación del Control remoto.

Operación de una Videocasetera

Programa el control remoto para utilizar con la Videocasetera.

PARA HACER ESTO...	OPRIMA
Encender/Apagar	POWER
Seleccionar modo de entrada de TV para la Videocasetera	TV/VIDEO
Cambiar canales arriba/abajo	PIP CH DVD/VCR CH
Grabar	REC
Reproducir	PLAY
Detener	STOP
Adelantar	PIP MAX FF
Regresar	PIP MIN REW
Pausar	PAUSE
Cambiar a modo TV o Videocasetera	FREEZE TV/VCR
Despliegue en pantalla	RECALL

Operación de decodificador de Cable

Programa el control remoto para utilizar con la caja de cable.

PARA HACER ESTO...	OPRIMA
Encender/Apagar	POWER
Seleccionar un canal	1 2 3 4 5 6 7 8 9 0
Cambiar el canal Arriba/Abajo	CH CH
Sintonizar el canal previo	R-TUNE

Operación de DBS

Programa el control remoto para utilizar con el DBS.

PARA HACER ESTO...	OPRIMA
Encender/Apagar	POWER
Desplegar menú DBS	MENU
Aspecto DBS	ASPECT
Navegar en menú	CH VOL VOL
Seleccionar Canal	1 2 3 4 5 6 7 8 9 0
Programar Información	RECALL
Sintonizar el Canal previo	R-TUNE
Cambiar a la siguiente página	PIP CH DVD/VCR CH
Salir del menú	EXIT

Operación de DVD





Programa el control remoto para utilizar con el DVD.

PARA HACER ESTO...	OPRIMA
Encender/Apagar	POWER
Capítulo anterior/siguiente	CH CH
Despliega menú del DVD	RECALL
Adelantar	PIP MIN REW
Retroceder	PIP MIN REW
Reproducir	PLAY
Abrir/Cerrar	SEARCH OPEN/CLOSE
Detener	STOP
Pausar	PAUSE

ESPAÑOL









Operación de reproductor de cassetes

Para operar un reproductor de cassetes, el control remoto debe ser programado en la opción AUX para la marca del equipo.

PARA HACER ESTO..	OPRIMA
Encender/Apagar	POWER 
Vol +/-	 VOL VOL 
Casetera A/B	R-TUNE 
Grabar	REC 
Reproducir	PLAY 
Detener	STOP 
Adelantar	PIP MAX FF 
Regresar	PIP MIN REW 
Pausa	PAUSE 





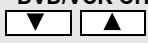









Operación de receptor de audio

Programa el control remoto para utilizar con el receptor de audio.

PARA HACER ESTO..	OPRIMA
Encender/Apagar	POWER 
Mudo	MUTE 
Vol +/-	 VOL VOL 
Estaciones pre-grabadas	 CH 
Para Seleccionar la modalidad de entrada ó componente:	Oprimir el teclado numerico del control remoto AV 1 Presione 1 AV 2 Presione 2 AV 3 Presione 3 AV 4 Presione 4 CD Presione 5 Radio Presione 6 Phono Presione 7 Cassette Presione 8 AUX Presione 9
Envolverte -	PIP MIN REW 
Envolverte +	PIP MAX FF 
Canal Central +/-	PIP CH DVD/VCR CH 

Operación de PVR (Grabadoras Personales de Video)

Para operar Grabadoras Personales de video, el control remoto debe ser programado en la opción AUX para la marca del equipo.

PARA HACER ESTO..	OPRIMA
Encender/Apagar	POWER 
Desplegar menú PVR	MENU 
Navegación	 VOL VOL   CH  CH
Seleccionar un canal	1 2 3 4 5 6 7 8 9 0
Reproducir	PLAY 
Grabar	REC 
Pausar	PAUSE 
Sintoniza el canal previo	R-TUNE 
Salir de menú	EXIT 
Volver a tocar zonas	R-TUNE 
Saltar rápido	SEARCH OPEN/CLOSE 
Regresar a vivo	PROG 
Cambiar canales arriba/abajo	PIP CH DVD/VCR CH 

Programando El Control Remoto



El Control Remoto Universal puede programarse para operar componentes de varios fabricantes usando los botones de función para VCR, DVD, DVD, DBS, RCVR, CABLE o AUX. Siga los procedimientos para programar su Control Remoto con o sin código para el componente.

Modos De Default Para El Control Remoto

Equipo	Funciona	Default
Televisión	Televisión (Solo Panasonic)	Código TV Panasonic
VCR	VCR (preajustado)	Código VCR Panasonic
DVD/CD	DVD y CD(preajustado)	Código DVD Panasonic
DBS	DBS (preajustado)	Código DBS Panasonic
RCVR	Receptor de audio (preajustado)	Código RCVR Panasonic
CBL	CABLE (preajustado)	Código CABLE Panasonic
AUX	Grabadoras Personales de Video y VCR2	Código PVR Panasonic

Nota: Determine el fabricante del componente y busque en la tabla su código.

Procedimiento

- Confirme que el componente esté conectado y en operación.
- Apague el componente.
- Presione los botones de  y  juntos, **cuando menos 5 segundos**.
- Presione el botón de la función apropiada del componente en el Control Remoto (VCR, DVD (CD), DBS, RCVR, CABLE o AUX (Grabadoras Personales de Video o VCR2)).
- Ponga el código del componente de 3 dígitos usando el teclado numérico (botones 0 ~ 9) del Control Remoto.
- Presione el botón  de el Control Remoto para probar el componente. Si éste procedimiento ha sido exitoso, el componente se encenderá.



Nota: Si el componente no opera con el Control Remoto, repita el procedimiento usando otro código. (Algunas marcas tienen múltiples códigos.)

Si un código se ha puesto incorrectamente, o si el procedimiento toma más de 30 segundos, la programación ha fracasado.

Programación Sin Código

Este procedimiento busca todos los códigos y se le llama "método de secuencia."

Procedimiento

- Confirme que el componente esté conectado y en operación.
- Apague el componente.
- Presione los botones  y  juntos, **cuando menos 5 segundos**.
- Presione el botón de la función apropiada del componente en el Control Remoto.
- Presione el botón **VOL ►** para ubicarse en el siguiente código. Presione el botón **◀ VOL** para regresar al código anterior.
- Presione el botón  de el Control Remoto para probar el componente. Si éste procedimiento ha sido exitoso, el componente se encenderá.

Nota: Repita los pasos anteriores hasta que el código del componente se halla encontrado. Puede tomar varios intentos hasta encontrar el código correcto.

- Después de que el código se ha encontrado, presione el botón  para guardar el código.

Códigos de Componentes

El Control Remoto Universal tiene capacidad de operar varias marcas de componentes después de introducir el código apropiado. A causa del límite de memoria no se han incluido todos los códigos existentes, por lo cual es posible que algunos componentes no operen. El Control Remoto Universal no controla todas la funciones y características disponibles en todos los modelos.

Escriba los números del código en este espacio. Esto le servirá como referencia cuando necesite programar su Control Remoto.		
Videocasetera <input type="text"/> <input type="text"/> <input type="text"/>	DVD <input type="text"/> <input type="text"/> <input type="text"/>	DVD (CD) <input type="text"/> <input type="text"/> <input type="text"/>
DBS <input type="text"/> <input type="text"/> <input type="text"/>	RECEPTOR <input type="text"/> <input type="text"/> <input type="text"/>	CABLE <input type="text"/> <input type="text"/> <input type="text"/>
AUX (PVR) <input type="text"/> <input type="text"/> <input type="text"/>	AUX (VCR2) <input type="text"/> <input type="text"/> <input type="text"/>	

Códigos de Componentes (cont.)

Códigos para VCR	
Marca	Código
Admiral	335
Aiwa	332
Akai	314, 315, 316, 329
Audio Dynamic	311, 339
Bell & Howell	305, 313
Broksonic	320, 326
Canon	323, 325
CCE	343
Citizen	306
Craig	305, 306, 329
Curtis Mathes	324, 345
Daewoo	301, 324, 343
DBX	310, 311, 339
Dimensia	345
Emerson	303, 319, 320, 325, 326, 343
Fisher	305, 307, 308, 309, 313
Funai	320, 326, 334
GE	324, 333, 345
Goldstar	306
Gradiente	334
Hitachi	300, 323, 345
Instant Replay	323, 324
Jensen	339
JVC	310, 311, 334, 339
Kenwood	306, 310, 311, 339
LXI	300, 305, 306, 307, 308, 309
Magnavox	323, 324, 331
Marantz	310, 311, 339
Marta	306
Memorex	309, 324
MGA	338, 340, 341, 347, 348
Minolta	300, 345
Mitsubishi	338, 340, 341, 347, 348
Multitech	304, 347
NEC	310, 311, 334, 339
Olympic	323, 324
Optimus	306, 321, 328, 335

Códigos para VCR (Cont.)	
Marca	Código
Orion	320, 326
Panasonic	321, 322, 323, 324
Penney	300, 305, 310, 311, 324, 339, 345
Pentax	300, 311, 345
Philco	320, 323, 324, 326, 331, 343
Philips	323, 324, 331
Pioneer	323
Proscan	300, 301, 302, 323, 324, 331, 333, 345, 346
Quasar	321, 322, 323, 324
Radio Shack	305, 309, 324, 333, 336, 340
RCA	300, 301, 302, 323, 324, 331, 333, 345, 346
Realistic	305, 309, 324, 336, 340
Samsung	302, 304, 333
Sansui	320, 326, 339, 352
Sanyo	305, 309, 313
Scott	301, 302, 304, 309, 320, 326, 338, 340, 347, 348
Sears	300, 305, 306, 307, 308
Sharp	335, 336
Shintom	317
Signature 2000	335
Singer	337
Sony	328, 329, 330
Sylvania	323, 324, 331
Tashiro	306
Tatung	310, 311, 339
Teac	310, 311, 339
Technics	321, 322, 323, 324
Teknika	324
Toshiba	301, 346
Vector Research	311
Wards	306, 309, 335, 336, 344
Yamaha	305, 310, 311, 339
Zenith	306, 344

Códigos para Decodificador de Cable	
Marca	Código
ABC	124
Archer	125, 132
Cableview	105, 132
Citizen	105, 122
Curtis	112, 113
Diamond	124, 125, 132
Eagle	129
Eastern	134
GCbrand	105, 132
Gemini	122
General Instrument/ Jerrold	111, 119, 120, 121, 122, 124, 125, 126, 127
Hamlin	112, 118, 140, 141, 142, 145
Hitachi	103, 124
Macom	103, 104, 105
Magnavox	133
Memorex	130
Movietime	105, 132
Oak	102, 137, 139
Panasonic	109, 110, 114
Philips	106, 107, 128, 129, 130
Pioneer	101, 116
Pulsar	105, 132
Puser	132
RCA	115
Realistic	132
Regal	112, 118, 140, 141, 142, 145, 149
Regency	134
Rembrandt	105, 132, 137
Samsung	105
Scientific Atlanta	111, 112, 113
Slmark	101, 105
Sprucer	105, 110
Stargate	105, 110
Televue	101, 105
Texscan	144
Tocom	135
Toshiba	104
Unika	125, 132
Universal	122, 132
Videoway	106
Viewstar	129, 130
Zenith	100, 117
Zenith/ Drake Satellite	100

Códigos para DBS	
Marca	Código
Dish Network (EchoStar)	105, 115, 116
EchoStar	105
Express VU	105, 115
G. E.	106
G.I. (General Instrument)	108
Gradiente	114
Hitachi	103, 111, 112
HNS (Hughes)	103
Magnavox	101, 102
Panasonic	104
Philips	101, 102
Primestar	108
Proscan	106, 109, 110, 113
RCA	106, 109, 110, 113
Sony	107
Star Choice	103, 108
Thoshiba	100
Uniden	101, 102

Códigos para DVD	
Marca	Código
Denon	100
Ferguson	101
JVC	109
Mitsubishi	105
Nordmende	101
Panasonic	100
Philips	103
Pioneer	102
RCA	101
Saba	101
Samsung	110
Sharp	108
Sony	104
Technics	100
Thomson	101
Toshiba	103
Yamaha	100
Zenith	107

Códigos de Componentes (Cont.)

Códigos para Equipos de Casete	
Marca	Código
Aiwa	223, 224, 225
Denon	231
Fisher	203
Jensen	214
JVC	229, 230
Kenwood	200, 207
Marantz	202
Nakamichi	205
Onkyo	208, 209, 213
Panasonic	216, 218
Philips	222
Denon	231
Fisher	203
Jensen	214
JVC	229, 230
Kenwood	200, 207
Marantz	202
Nakamichi	205
Onkyo	208, 209, 213
Panasonic	216, 218
Philips	222
Pioneer	204
RCA	226, 227, 228
Sansui	205, 210
Sharp	231
Sony	219, 220
Teac	210, 211, 215
Technics	216, 218
Yamaha	201, 202

Códigos para Receptores	
Marca	Código
Admiral	120
Aiwa	125, 126
Denon	134, 135, 136
Fisher	104
Garrard	113
Harman Kardon	115, 123
Jensen	129
JVC	132, 133
Kenwood	100, 108
Magnavox	127
Marantz	124
McIntosh	116
Nakamichi	106
Onkyo	109, 114
Optimus	103, 127, 130, 131
Panasonic	118, 119, 121
Philips	123
Pioneer	105, 107
Quasar	118, 119, 121
RCA	103, 105, 127, 130, 131
Sansui	103, 111, 139
Sharp	134, 137
Sony	122
Soundesign	138
Teac	111, 112, 113
Technics	118, 119, 121
Victor	132, 133
Yamaha	101, 102

Códigos para reproductor de CD	
Marca	Código
Admiral	226
Aiwa	233, 235
Carver	229
Denon	242
Emerson	239
Fisher	205
Harman/Kardon	219, 220, 221, 223
Hitachi	207
Jensen	234
JVC	240, 241, 245
Kardon	223
Kenwood	200, 201, 211, 245
LXI/Sears	236
Magnavox	229, 232
Marantz	229
McIntosh	221
Nakamichi	210
Onkyo	214, 215
Optimus	208, 218, 220, 222
Panasonic	224, 225, 227
Philips	229, 230
Pioneer	208
Quasar	224, 225, 227
RCA	231, 237, 238, 247
Sansui	210, 246
Sanyo	205
Scott	210, 246
Sharp	242, 243
Sherwood	220
Sony	228
Soundesign	244
Teac	212, 216, 218
Technics	224, 225, 227
Victor	240, 241, 245
Yamaha	202, 203, 204

Códigos para Grabadoras Personales de Video	
Marca	Código
Panasonic Replay TV	100
Philips Tivo	102
Sony Tivo	101

Navegación básica del menú

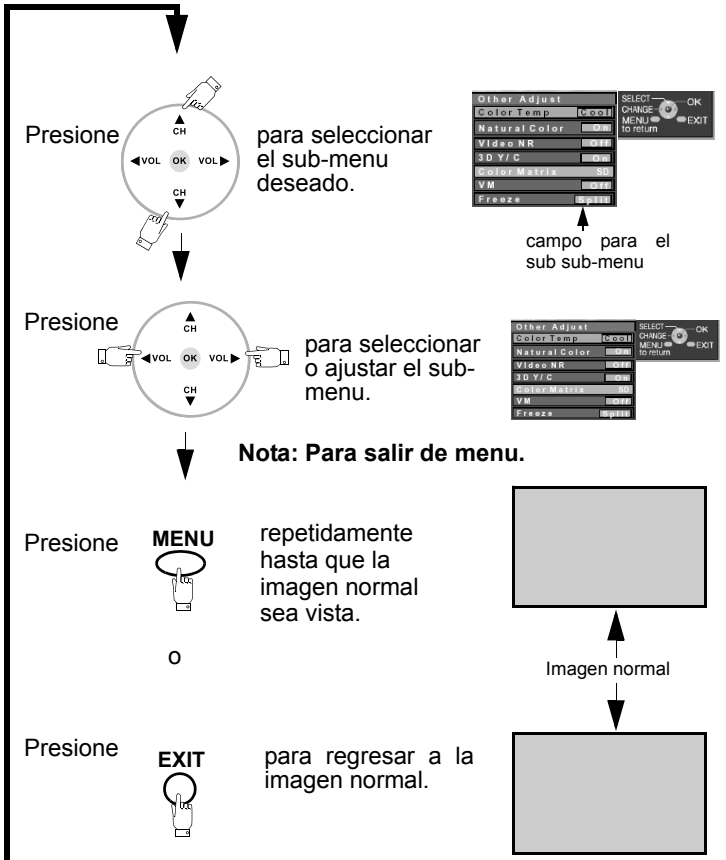
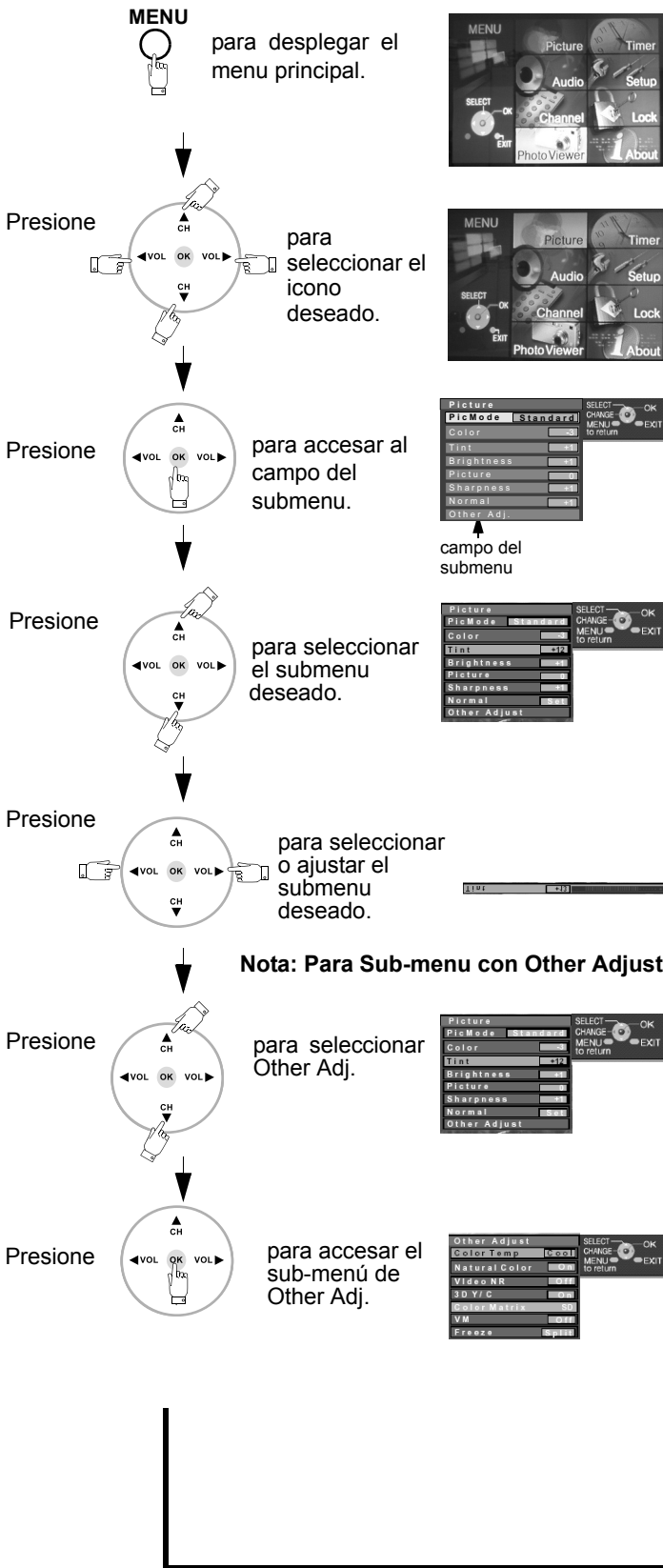

ESPAÑOL

Operación del Menú

Picture (IMAGEN)

Nota: Mientras la funciones del sub-menu estan remarcadas, presione **VOL ▶** para ajustar o activar.

- MODO - Le permite escoger uno de tres modos de imagen preseleccionados para ver el programa. El seleccionar esta función también afectara Temp Color.
 - VIVIDO - Este el modo de fábrica. Crea una imagen de contraste y nitidez mejorados para ver se en un cuarto bien iluminado.
 - ESTANDAR - Este el modo de fábrica. Crea una imagen de contraste y nitidez mejorados para ver se en un cuarto bien iluminado.
 - CINEMA - Seleccione este modo par ver peliculas en un cuarto oscuro. Provee una imagen más suave, tipo cine.

Nota: Cada modo tiene sus propios ajustes de imagen (Color, brillo, tinto, contraste y nitidez).

- COLOR - Ajusta la intensidad del color deseada.
- TINTE - Ajusta los tonos naturales de la piel.
- BRILLO - Ajusta las áreas oscuras para detalles más nítidos.
- CONTRASTE - Ajusta las área blancas de la imagen.
- NITIDEZ - Ajusta para dar mejor claridad a los detalles de la silueta.
- NORMAL - Reajusta todas las modificaciones de la imagen a los predispuestos de fábrica.

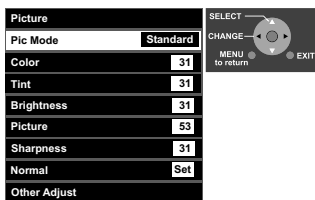

Other Adjust (Otros Ajustes)

Seleccione OTROS AJ. y presione **OK** par desplegar el sub sub-menu.

Nota: Mientras las funciones del sub sub-menu estan remarcadas, presione **◀ VOL** o **VOL ▶** para seleccionar o activar.

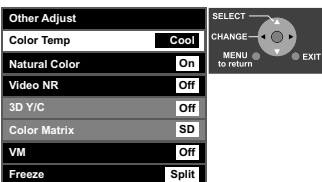

- TEMP COLOR (temperatura) - Para aumentar o disminuir el rojo y e azul para acomodarse a las preferencias personales.
- COLOR NATURAL - Esta función expande el rango de reproducción del color, lo que resulta en imagenes mas vivas con una graduación de colores mas natural y tonos mas delicados.
- REDUC DE RUIDO - Reduce el ruido de canal normalmente llamado "nieve".
- 3D Y/C FILTRO - Minimiza el ruido y cruce de color en la imagen.
- MATRIZ COLOR - Disponible solo con señal 480p. Seleccione HD o SD para ajuste automático de los parámetros de color para transmisiones de HD (alta definición) y SD (definición estándar). Esta función no se

puede seleccionar cuando se ve programación regular de TV (NTSC).

Nota: Cuando esté viendo una señal de DTV en un formato no-estándar, puede cambiar los parámetros de color manualmente para obtener una mejor calidad de imagen.

- MV (Velocidad de modulación) - Incrementa la nitidez de la imagen y da mejor transición de blancos a negros.
- FREEZE - Esta función es usada da para congelar la imagen principal y desplegarla en la IDI or pantalla SPLIT cuando el botón FREEZE en el control remoto es presionado. Presione FREEZE de nuevo para eliminar la pantalla.

Nota: Los botones SWAP, SEARCH, SIZE, PIP MIN y PIP MAX no funcionan en este modo

AUDIO

Nota: Mientras la funciones del sub-menu estan remarcadas, presione **VOL ▶** para ajustar o activar.

- BAJOS - Aumenta o disminuye los sonidos bajos
- ALTOS - Aumenta o disminuye los sonidos altos.
- BALANCE - Enfatisa el volumen del altavoz derecho / izquierdo.
- NORMAL - Reajusta BAJOS, ALTOS y BALANCE a los niveles prefijados de fábrica.

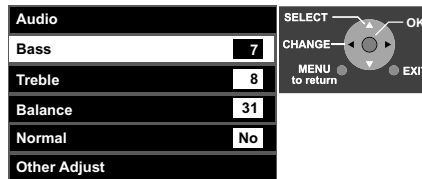

Other Adjust (Otros Ajustes)

Nota: Mientras las funciones del sub sub-menu estan remarcadas, presione **VOL ▶** para seleccionar o activar.

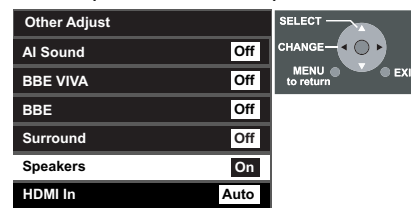

- SONIDO IA - Automáticamente mantiene el volumen constante entre programas y comerciales.
- BBE® - La tecnología de sonido BBE® mejora el entendimiento de los discursos y restaura el rango dinámico de pasajes musicales para proveer un sonido natural sobresaliente.
- BBE VIVA 3D - BBE VIVA provee una imagen precisa natural 3D con sonido hi-fi. La claridad del sonido es mejorada por BBE mientras el ancho, profundidad y altura de la imagen del sonido 3D BBE. BBE VIVA es compatible con toda la programación de TV incluyendo noticias, musica, dramas, peliculas y deportes así como también juegos electronicos. BBE VIVA mejora el efecto del sonido envolvente, mientras mantiene la claridad del dialogo.

Nota: BBE VIVA 3D solo esta disponible para los modelos PT-53TWD63 y PT-56TWD63.

AUDIO (cont.)

Other Adjust (OTROS AJUSTES)

- SURROUND - Sonido envolvente tridimensional con dos altavoces.
- SPEAKERS - Esta función le permite encender o apagar los altavoces.
 - On - Los Altavoces funcionan normalmente.
 - Off - Los altavoces no funcionan.
- HDMI In - Cuando se utilice HDMI, esta opción le permitirá cambiar entre entrada analoga y entrada digital.
 - Auto - Selecciona automaticamente señal analoga/ Digital.
 - Digital - Solo entrada digital.
 - Analog - Solo entrada Analoga.

Channels (CANALES)

FAVORITE - Le permite crear una lista de canales favoritos de la Antena (A) o Antena (B).

- ❑ **SURF MODE** - Seleccione FAVORITE o ALL CHANNELS con los botones ◀ VOL o VOL ▶, luego presione el botón OK.
- ❑ **RF Input** - Seleccionar Antena (A) o Antena (B).
- ❑ **CHANNEL** - Use los botones ◀ VOL o VOL ▶ para seleccionar los canales, después presione OK para añadir. Para remover el canal, presione OK mientras el número del canal este desplegado.

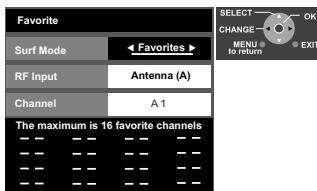

Captions - Para añadir etiquetas manuales o preseleccionadas a canales deseados. También coloca etiquetas a las entradas de video.

- ❑ **Preset Labels (Prefijado)** - Asigne los números de canal para los títulos/siglas prefijados.

Procedimiento

- Presione el botón OK mientras Preset Labels tiene seleccionado la entrada RF Input, luego presione ◀ VOL o VOL ▶ para seleccionar Antena (A) o Antena (B).

Nota: Solo entradas con señal podrán ser seleccionadas.

- Presione OK para subrayar su selección.
- Presione CH ▼ para seleccionar el título prefijado deseado.
- Use los botones numéricos del control remoto para seleccionar el canal deseado (hacer referencia a su guía de TV local).

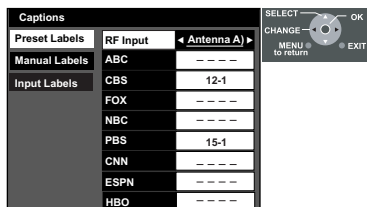

Nota: Para borrar un canal, presione ◀ VOL cuando el canal está seleccionado

- ❑ **Manual Labels (Títulos Manuales)** - Para introducir los números y títulos manualmente.

Procedimiento

- Presione OK cuando Títulos Manuales esta seleccionado a la señal de entrada RF, luego presione ◀ VOL o VOL ▶ para seleccionar Antena (A) o Antena (B).

Nota: Solo entradas con señal podran ser seleccionadas.

- Presione OK para subrayar su selección.
- Presione CH ▼ para seleccionar CHANNEL, luego presione ◀ VOL o VOL ▶ para seleccionar el número de canal disponible.
- Presione OK para subrayar su selección.
- Presione CH ▼ para seleccionar CAPTION.
- Presione VOL ▶ para seleccionar la posición del primer caracter, luego presione CH ▲ o CH ▼ seleccionar el caracter.
- Repita hasta que todos los caracteres sean introducidos, hasta siete caracteres pueden ser introducidos por canal.
- Use los botones numéricos del control remoto para seleccionar el canal deseado.

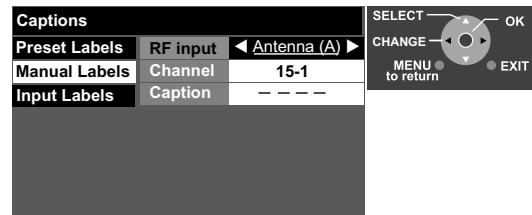

- **Input Labels (Títulos de entradas de video)** - Para clasificar las conexiones de entrada de video que se visualizan en la pantalla.

Procedimiento

- Presione OK mientras Input Labels tiene seleccionado COMPONENT 1, después presione ◀ VOL o VOL ▶ para seleccionar la etiqueta de entrada predefinida para COMPONENT 1.
- Presione OK para subrayar la selección.
- Presione CH ▼ para seleccionar otra entrada, repita el procedimiento para agregar mas títulos a las entradas.

Nota:

- Para remover los títulos seleccione la entrada deseada, presione ◀ VOL o VOL ▶ hasta que un guión (-) sea mostrado.
- Presione OK para subrayar el guión (-).

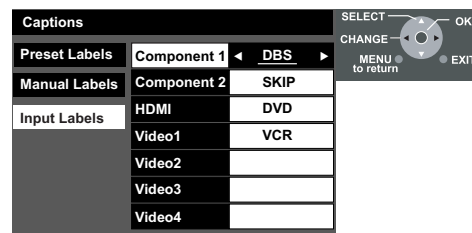

Operación del Photo Viewer™

El Photo Viewer le permite mostrar imágenes JPEG grabadas en una tarjeta SD o PCMCIA cuando es insertada en la abertura correcta.

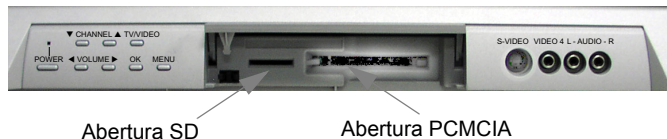

Notas:

- Otros tipos de tarjetas de memoria pueden ser insertados en la abertura PCMCIA usando el adaptador de tarjeta apropiado.
- Las tarjetas de memoria no son incluidas con este televisor.

Tarjetas de memoria compatibles que pueden ser usadas con el Photo Viewer™

Tipo de tarjeta	Capacidad máxima
SD, MMC (Multi Media Card), Smart Media*, Compact Flash* Memory Stick*, xD-Picture Card*, Flash ATA*, memory Stick Pro*	SD - 512MB, MMC - 64MB Smart Media - 128MB, Compact Flash - 1 GB Memory Stick - 128MB xD-Picture Card - 128MB Flash ATA - 128MB Memory Stick Pro - 1GB

*Estas tarjetas requieren de un adaptador PCMCIA estándar.
Nota: Photo Viewer™ no es compatible con discos duros tipo tarjeta (Micro Drive, Mobile type hard disk, etc.)

Insertando y removiendo tarjetas SD o PCMCIA

ADVERTENCIA: Como con cualquier objeto pequeño, las tarjetas SD pueden ser tragadas por niños pequeños. Remueva la tarjeta SD inmediatamente despues de usarla.

Procedimiento

- ❑ Tarjeta SD - Introduzca la tarjeta SD en la abertura SD hasta que haga click. Presione la tarjeta de nuevo para removerla.
- ❑ Tarjeta PCMCIA - Introduzca la tarjeta hasta que asiente firmemente. Para remover la tarjeta, presione el botón en el lado derecho de la abertura. Previo a remover la tarjeta PCMCIA, asegurese de apagar el televisor. De otra manera, puede dañar el televisor.

Información sobre las tarjetas de memoria

- Las tarjetas de memoria deben estar formateadas con FAT12 o FAT16 para que puedan ser accedidas. Si la tarjeta no esta formateada puede ocasionar incompatibilidad con algunos adaptadores de tarjetas. Si esto sucede, reformatee la tarjeta utilizando su cámara digital. Vea el manual de su cámara para más información.
Nota: Al reformatear la tarjeta se borrarán todas las imágenes en ella.
- Si el JPEG es modificado usando una PC, este no sera visto en el televisor.

Operación básica

Introduzca ya sea la tarjeta SD o PCMCIA en la abertura correspondiente. La imagen desaparece de la pantalla mientras el Photo Viewer accesa la información de la tarjeta. Despues de acceder las imágenes de la tarjeta, aparecera una imagen con previsualizaciones en pantalla. Use los botones de navegación para seleccionar la previsualización deseada y presione **OK** para

mostrar la imagen en pantalla. Use **◀ VOL** o **VOL ▶** para seleccionar la imagen previa o siguiente. Presione **EXIT** para salir del Photo Viewer.

Photo Viewer™ - Modo de previsualización

La pantalla de previsualización es la primera pantalla accedida desde el menú principal. Muestra la cantidad total de imágenes en la tarjeta, el nombre del archivo (número de folder y el número de la previsualización seleccionada), la fecha en que la foto fué tomada y la resolución de la misma.

Procedimiento

- Presione **MENU** para acceder el menú principal.
- Seleccione el icono Photo Viewer usando los botones de navegación (izquierda/derecha/arriba/abajo).
- Presione **OK** para mostrar la pantalla de previsualizaciones.

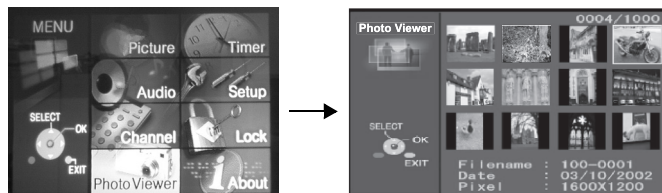

- Seleccione la previsualización deseada usando los botones de navegación.
- Presione **OK** para ver la imagen seleccionada.
- Cambie la imagen presionando los botones **◀ VOL** o **VOL ▶**.
- Para girar la imagen (en caso de ser necesario), use los botones **CH ▼** o **CH ▲**.

Notas:

- Número máximo de carpetas que pueden desplegarse: **100**.
- Tamaño máximo de archivo: **3000**. Cualquier carpeta con archivos más grandes no será mostrada.
- **Resolución de imagen:** Compatible en el rango 64x64 - 8192 x 8192 (sub-muestreo 4:2:2 o 4:2:0)
- Si la imagen es importada de una PC, debe usar el formato EXIF (Exchangeable image file format) 2.0, 2.1, 2.2 además del formato DCF (design rule for Camera File system), o no podrá ser desplegada.
- Si el JPEG es modificado usando una PC, no será desplegado en el televisor.
- El Photo Viewer™ no puede mostrar JPEG animado o imágenes fijas no formateadas con DCF (ejem. TIFF, BMP).
- Si el archivo esta parcialmente corrompido, podría ser mostrado a una resolución menor.
- Si la tarjeta SD y la PCMCIA son insertadas al mismo tiempo, la tarjeta SD tiene prioridad. De lo contrario, la última tarjeta insertada tiene prioridad.
- No quite la tarjeta SD o PCMCIA mientras el Photo Viewer™ este accedando la información (cuando el icono de la tarjeta esta destellando). Esto podría dañar la tarjeta de memoria o el televisor.

Operación del Photo Viewer™ (Cont.)

Menú de Setup del Photo Viewer™

Este menú le permite ajustar varios parámetros del Photo Viewer.

Procedimiento

- Seleccione el icono del Photo Viewer y presione **OK** para mostrar la pantalla de previsualización.
- Presione el botón **SD** en el control remoto para mostrar el menú de Setup.
- Use los botones **CH▼▲**, **◀ VOL** o **VOL ▶** para navegar en el menú.

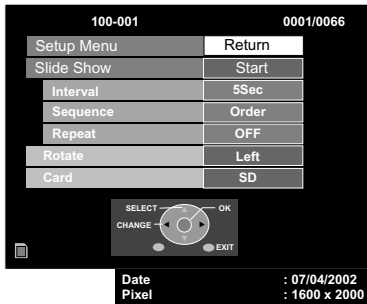

En este menú podrá ajustar las opciones del Photo Viewer.

- Slide Show - Le permite comenzar un slide show presionando **OK** si la opción Start esta seleccionada. Presione **OK** para detener el Slide show.

Nota: Cuando esta en modo de Slide show, puede cambiar el aspecto de la imagen en pantalla presionando el botón **ASPECT** en el control remoto.

- Interval - Le permite ajustar el tiempo que la imagen aparece en pantalla. Los tiempos disponibles son: 5seg, 10seg, 15seg, 30seg, 60seg, 90seg y 10 minutos.
- Sequence - Seleccione en orden o aleatorio.
- Repeat - Para repetir el Slide show automáticamente.

Nota: Una vez ajustados Interval, Sequence o Repeat, presione **CH ▲** para seleccionar Start, luego presione **OK** para salvar los ajustes y empezar el Slide Show.

- Rotate - Le permite girar la imagen.
- Zoom - Le permite ajustar la magnificación de la imagen en pantalla. Presione **OK** aplicar el grado de magnificación seleccionado. Para mover la imagen presione los botones de navegación.

Procedimiento

- Estando en el modo de despliegue de imagen sencilla (Single Slide display mode), presione **SD** para acceder el menú de ajuste del Photo Viewer™. La opción Zoom será mostrada en el menú de ajuste.
- Seleccione Zoom y presione **OK**.
- Presione **◀ VOL** o **VOL ▶** para elegir To Fit, x2 o x4.
- Presione **OK**. Para mover la imagen en el marco de la imagen utilice los botones de navegación.
- Card - Selecciona entre la tarjeta SD o PCMCIA cuando ambas se encuentran insertadas.

A continuación se muestran unos de los mensajes de error que pueden ser mostrados en pantalla cuando algunas condiciones no se cumplen o exceden las especificaciones del Photo Viewer™.

Mensajes de error

Error	Mensaje mostrado en pantalla
Al momento de insertar la tarjeta	No hay tarjeta o la tarjeta no fué insertada correctamente.
Archivo JPEG corrompido y no puede decodificarse.	Este tipo de imagen es válido.
El archivo no esta formateado con FAT 12 o FAT 16 o no cumple con el estándar DCF.	Este tipo de formato no es válido.
La previsualización o la imagen principal no pueden ser mostradas	 Aparecerá este ícono donde debería aparecer la previsualización.
Más de 3000 archivos	Photo Viewer™ no puede acceder más de 3000 archivos JPEG.
Excede la resolución	Photo Viewer™ no puede acceder imágenes de más 8192x8192 píxels..
Tarjeta no compatible es insertada	Este tipo de tarjeta no es válido..

Localización de fallas del Photo Viewer™

Sintomas	Soluciones
No puede leer el contenido de la tarjeta	A). Formato incompatible. Debe ser formateado con FAT 12 o FAT 16. B) La extensión no es "JPG". El Photo Viewer solo puede mostrar archivos JPEG con el estándar EXIF. C) Las carpetas no cuentan con el estándar DCF.
La tarjeta no puede ser removida	Presione la tarjeta hasta que quede insertada completamente y luego remuevala.
Calidad de imagen pobre	Si la imagen principal no puede ser accesada (el archivo está parcialmente corrompido), el photo viewer accesará la previsualización. Confirme el formato de la imagen.
Long time to display	It will take long time to display, if there are lots of images or if the file size is big.

Notas:

- Si las previsualizaciones o una imagen son mostradas por más de 10 minutos, Movimiento de imagen (Image shift ver pág. 26) se activará para prevenir la retención de imagen. La imagen en pantalla se agrandará y reducirá en cuatro (4) pasos. Para salir de este modo, presione **OK** o seleccione otra imagen o presione otro botón.
- Durante el Slide show, el movimiento de imagen será activado si la imagen es mostrada por más de cinco (5) minutos. La imagen se moverá horizontalmente (izquierda o derecha) en incrementos de minutos. El movimiento de imagen no se activará si está apagado.

Timer (CRONOMETRO)

Este menú le permite ajustar los cronómetros (Sleep y Timer), la hora y el día de la semana.

- ❑ **APAGADO (Sleep)** - En el menú de Cronómetro, seleccione Apagado para programar la Televisión en 30, 60 ó 90 minutos. Seleccione NO para desactivar el Cronómetro.

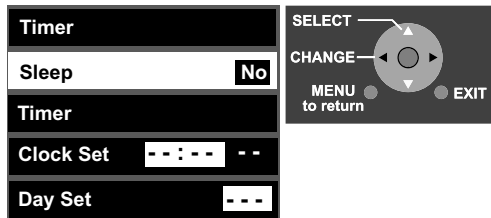

Procedimiento

- Presione **MENU** para desplegar el menú principal.
- Seleccione el icono Timer usando los botones de navegación.
- Presione el botón **OK** para desplegar el menú Timer (Cronómetro).
- Presione el botón **VOL ▶** para seleccionar 30, 60, 90 minutos o No.
- ❑ **Timer (Cronom)** - Seleccione cronómetro, para encender y apagar la televisión a la hora y los días seleccionados.

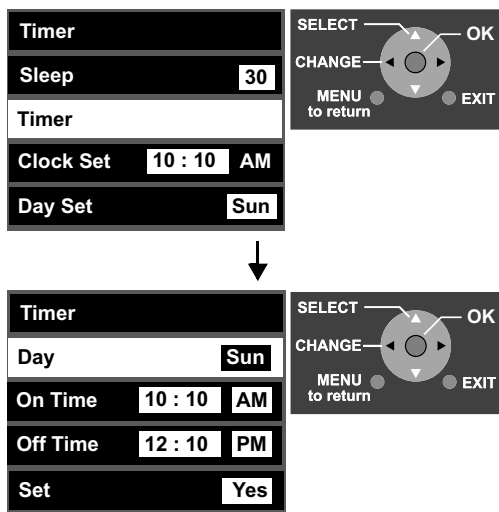

Procedimiento

- Dentro del menú Timer, presione **CH ▼** para seleccionar Timer.
- Presione **OK** para mostrar el sub-menú de Timer.
- Presione **◀ VOL** o **VOL ▶** para seleccionar el día deseado.
- Presione **CH ▼** para colocarse en On Time.
- Presione **OK** para colocar la hora. Presione **CH ▲** o **CH ▼** para ajustar la hora (AM o PM).
- Presione **VOL ▶** y **CH ▲** para ajustar los minutos.
- Presione **OK** o **MENU** para grabar los ajustes.
- Presione **CH ▼** para colocarse en Off Time y repita el mismo procedimiento para colocar la hora.
- Presione **CH ▼** para colocarse en Set y seleccione Yes o No.
- Presione **EXIT** para salir del menú.

- Introduzca el canal deseado con los botones numéricos y el botón **PROG** (en caso necesario). El televisor sintonizará este canal cuando el cronómetro se active.
- Apague el televisor.
- El televisor se encenderá a la hora seleccionada y a el canal que se tenía al momento de apagar el televisor.

Notas:

- El reloj debe ser ajustado antes de programar Timer. Use los botones de navegación para seleccionar el icono de Timer.
- La televisión se activado automáticamente después de 90 minutos cuando se encendió con el CRONOMETRO. Si se selecciona APAGAR o si se presiona una tecla, el apagado automático de 90 minutos se cancela.

- ❑ **Ajuste del reloj** - Ajuste la hora de la semana .

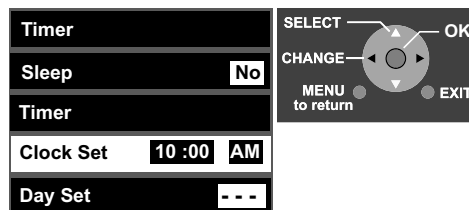

Procedimiento

- En el menú de Timer, presione **CH ▼** para colocarse en Clock Set y presione **OK**.
- Presione **CH ▲** o **CH ▼** para ajustar la hora (AM o PM).
- Presione **VOL ▶** para pasar al siguiente campo. Presione **CH ▲** o **CH ▼** para ajustar los minutos. Presione **MENU** o **OK** para regresar a la pantalla de Timer.

- ❑ **Day Set** - Seleccione el día de la semana.

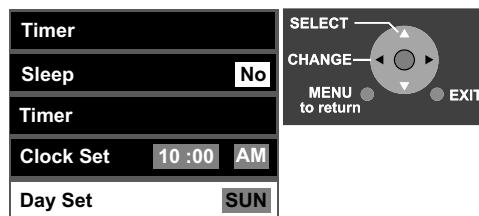

Procedimiento

- Presione **CH ▼** para colocarse en Day Set y seleccione el día de la semana usando **◀ VOL** o **VOL ▶**.
- Presione **EXIT** para salir del menú.

SET UP (AJUSTE)

El menú de Set Up le permite seleccionar la antena, programar canales análogos o digitales, seleccionar subtítulos análogos y digitales, ajustar la convergencia, el auto encendido, movimiento de imagen y ajuste de magnificación.

Procedimiento

- Presione el botón **MENU** para desplegar el menú principal.
- Presione **▼ CH** , **CH ▲**, **◀ VOL** o **VOL ▶** para seleccionar el icono de Set Up.
- Presione **OK** para mostrar las opciones del menú de Setup.

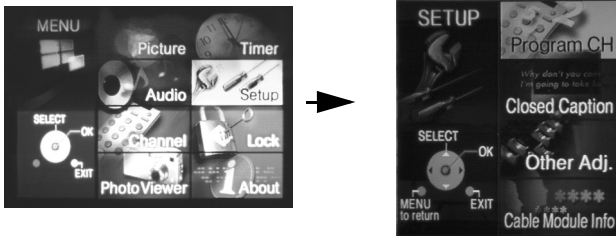

Program CH (Programar canales)

Este menú le permite seleccionar la antena, autoprogramar todos los canales análogos o digitales disponibles, manualmente agregar o remover canales y mostrar la fuerza de la señal recibida de los canales digitales.

- ☐ **Input Setup** - Sirve para seleccionar el modo de antena (Cable Only, Cable/Antenna o Antenna Only).

Nota: Puede conectar una antena de cable o terrestre al conector Ant A. Pero, si tiene ambas, la antena del Cable **debe** ser conectada al conector Ant A y la antena terrestre al conector Ant B.

Procedimiento

- En el menú de ajuste (Set Up), seleccione Program Channel y presione **OK**.
- Presione **OK** para entrar al sub-menú. Presione **◀ VOL** o **VOL ▶** para seleccionar Cable Only, Cable/Antenna o Antenna Only.
- Presione **OK**. Cuando la siguiente pantalla sea desplegada, presione **OK** para iniciar la auto programación. La auto programación debe hacerse cuando seleccione la señal de entrada por primera vez o cuando cambie la configuración de la antena.

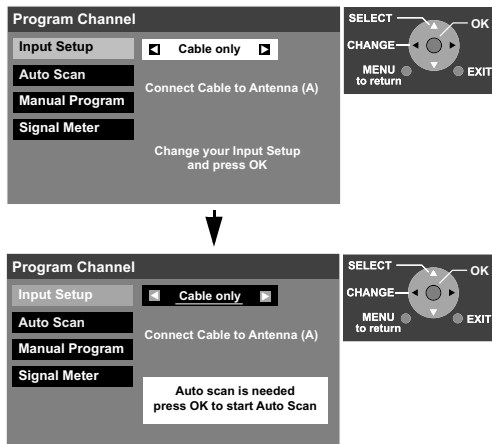

Notas:

- Si selecciona Cable Only, Antenna Only o Antenna/Cable y el módulo POD no está conectado, la auto programación hará un Scan All (búsqueda completa).
- Si Cable Only es seleccionado y el módulo POD está conectado, el Auto scan no se hará.
- Si Cable/Antenna es seleccionado y el módulo POD está conectado, Antenna (B) Analog y Digital Auto scan se llevarán a cabo.

- ☐ **Auto Scan (Auto Programación)** - Programa automáticamente todos los canales disponibles.

Procedimiento

- Coloque en Auto Scan y presione **OK** para entrar al sub-menú.
- Use **▼ CH** y **CH ▲** para seleccionar Scan All y presione **OK** para iniciar. Una vez terminada la auto programación presione **MENU** para regresar al menú anterior.

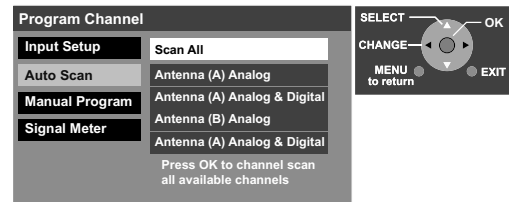

- ☐ **Manual Program (Programación Manual)** - Para agregar o borrar canales manualmente.

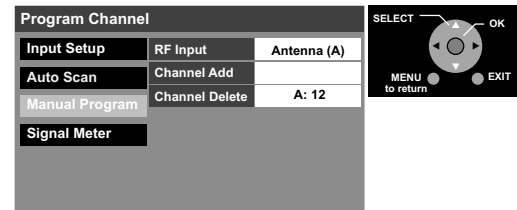

- ☐ **Signal Meter (Medidor de señal)** - Muestra la fuerza de la señal digital ATSC recibida ya sea en Antena (A) o Antena (B).

Nota: Esta función no esta disponible para canales análogos.

Procedimiento

- Coloque en Signal Meter y presione **OK** para entrar al sub-menú.
- En el campo RF Input, seleccione Antenna (A) o Antenna (B).
- Seleccione el canal usando **◀ VOL** o **VOL ▶**.
- Presione **OK** para mostrar la fuerza de la señal.

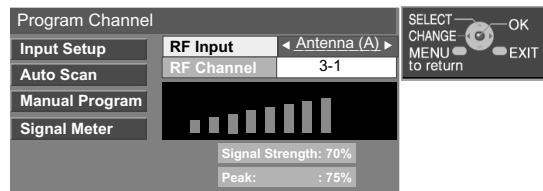

Nota: El color de las barras indica usualmente la fuerza de la señal recibida.

- Verde - Señal adecuada para buena recepción.
- Amarillo - Señal pobre.
- Rojo - Señal muy pobre.

Closed Caption (Subtítulos)

Este televisor incluye un decodificador integrado que es capaz de mostrar subtítulos del sonido escuchado. El programa visto debe proveer subtítulos para que el televisor pueda mostrarlos. Puede ajustar sus preferencias para los subtítulos digitales y los análogos.

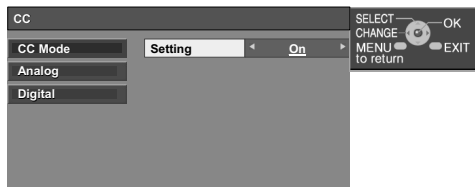

- CC Mode (Modo CC)** - Seleccione On, Off o Mute.
 - Off - Cuando no se desea la modalidad de subtítulos.
 - On - Para desplegar Subtítulos.
 - On Mute - Active la modalidad de subtítulos en pantalla cuando el audio es silenciado.

Analog (Análogo)

- Le permite ajustar las opciones de los subtítulos análogos.
- En el menú Closed Caption, seleccione Analog y presione **OK** para entrar al sub-menú.
 - Presione **◀ VOL** o **VOL ▶** para seleccionar la opción deseada:
 - CC1 - Para que la información relacionada con el vídeo sea desplegada en hasta 4 líneas en pantalla a la vez. (No bloquea partes relevantes de la imagen). El texto puede ser en cualquier idioma.
 - CC2 a CC4 - Otras modalidades de información relacionada con el video.
 - T1 a T4 - Para que la guía de la programación o cualquier otra información sea desplegada en pantalla, cuando este disponible. (Bloquea una gran porción de la imagen en la pantalla de la televisión).
 - Presione **MENU** para regresar al menú de Closed Caption.

Digital

Este menú le permite configurar el tipo de servicio de los subtítulos, tipo de letra, tamaño de letra y estilo de letra. El sub-menú Color le permite configurar el color de la letra, el color del fondo en que el texto es mostrado, la opacidad de la letra, la opacidad de la caja de texto y el filo de la sombra (si esta es seleccionada).

Sub-menú Colors

- En el sub-menú de subtítulos digitales, seleccione Colors y presione **OK**.

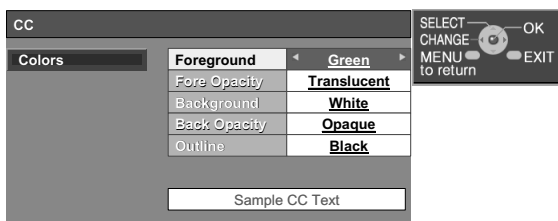

Nota: Cuando se utilizan los subtítulos digitales, la salida para monitor (Prog Out) también mostrará los subtítulos. Esto significa que si graba el programa, los subtítulos también serán grabados. Para evitar esto, apague los subtítulos digitales o utilice los análogos.

Other Adj. (Otros ajustes)

El menú Other Adj. le permite configurar el auto encendido, la convergencia, el movimiento de imagen y la magnificación.

- Auto Power On (Autoencendido)** - Seleccione SET para encender la televisión al mismo tiempo que el Decodificador de Cable u otros componentes, o seleccione Off.
- Image Shift (Movimiento de imagen)** - Esta función ayuda a evitar la retención de imagen causada por ver imágenes fijas por un periodo extendido de tiempo. La imagen es corrida a la izquierda o derecha en pequeños incrementos si una imagen fija se deja en pantalla por un periodo extendido de tiempo. Es recomendado seleccionar On para esta opción.
- Convergence (Convergencia)** - Esta función le permite ajustar la convergencia en caso de ser necesario.
- Zoom Adjust (Magnificación)** - Esta función le permite ajustar el tamaño de la magnificación y su posición vertical.

Procedimiento

- En el menú Set Up, seleccione Other Adj. y presione **OK** para entrar al sub-menú.
- Use **▼ CH** o **CH ▲** para navegar. Presione **◀ VOL** o **VOL ▶** para seleccionar o presione **OK** para mostrar el sub-menú de Convergence o Zoom Adjust.

Convergence (Convergencia)

Nota: Solo use los botones del control remoto mientras ajusta la convergencia. El panel de control frontal no tiene efecto.

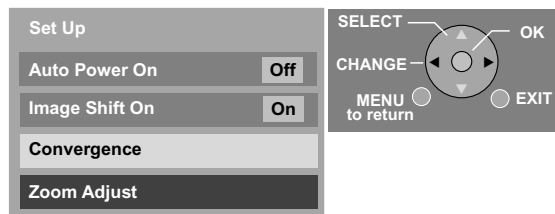

Nota: La convergencia no suele necesitar ajuste, excepto después de mover el televisor o para hacer ajustes menores.

Procedimiento

- Presione **OK** para seleccionar el campo de Convergence.
- Presione **CH ▲** o **CH ▼** para ajustar:
 - Convergence Adj. - Seleccione para realizar el ajuste de convergencia.

Nota: Una vez seleccionado, presione **OK** para continuar el ajuste.

- Reset to Default - Seleccione para regresar la convergencia a su ajuste de fábrica.

Nota: Una vez seleccionado, presione **OK** para aplicar el ajuste.



Convergence Adj. (Ajuste de Convergencia)

Procedimiento

- Después de presionar **OK** se desplegará la pantalla para alinear el verde al centro.
- Después utilice los botones de navegación en el control remoto para alinear las líneas verdes horizontales y verticales en la pantalla, con las marcas de referencia del gabinete en la parte central superior, inferior, izquierda y derecha.

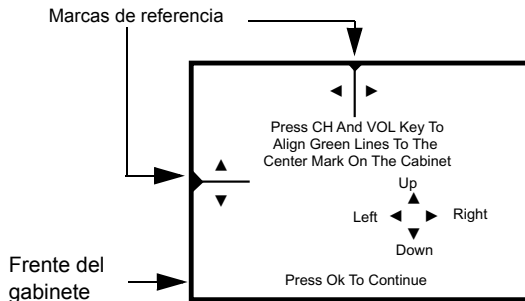

- Presione **OK** para mostrar la imagen de corrección de rojo al centro.
- Use los botones de navegación para alinear la cruz ROJA con el patrón blanco.

Nota: PARA PREVENIR DAÑO AL TUBO DE LA IMAGEN, NO DEJE ENCENDIDO EL PATRON DE PRUEBA POR UN PERIODO DE TIEMPO PROLONGADO.

- Presione **"0"** en el teclado de control remoto para desplegar la pantalla para corrección del **AZUL**, después repita el procedimiento para ajustar el azul. De ser necesario presione **"0"** nuevamente para regresar a la pantalla para corregir el **ROJO**.

Nota: Un patrón de cruz ajustado aparece blanco con un mínimo de color saliente.

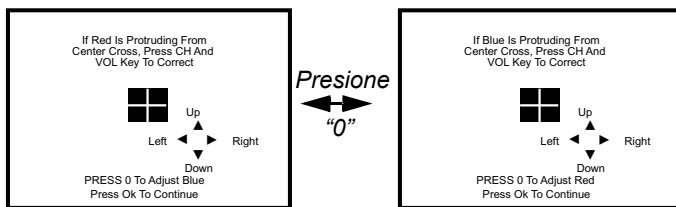

Corrección de convergencia en nueve puntos

Nota: El control remoto debe estar en modo de TV.

Procedimiento

- Presione el botón **OK** para desplegar el menú convergencia **ROJO**.
- Presione los botones de 1 al 9 en el control remoto para seleccionar posición de corrección de convergencia.
- Use los botones de navegación para alinear la cruz **ROJA** con la cruz blanca.

Nota: Un patrón de cruz ajustado aparece blanco con un mínimo de color saliente.

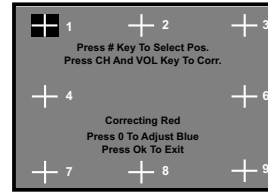

- Presione **"0"** en el teclado del control remoto para desplegar la pantalla para corrección de **AZUL**, después repita el procedimiento.

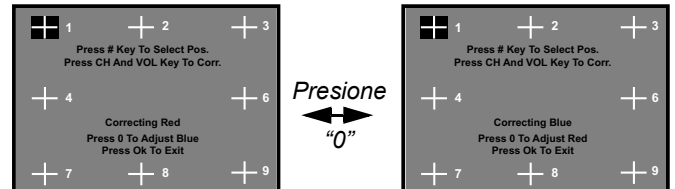

- Para salir presione el botón **OK**, después presione **EXIT** para salir todos menús.

Cable Module Info (Información del módulo del Cable)

Este menú es usado para proveer información cuando un módulo DCM (Módulo de Cable Digital) es introducido en el conector DCM INTERFACE (POD INTERFACE) en la parte posterior del televisor. Si no hay un DCM conectado y trata de acceder la información del módulo de cable, el mensaje 'Cable Module Not present' se mostrará en pantalla. Para utilizar las funciones ofrecidas por su compañía de cable, puede ser requerido suscribirse a esos servicios.

Nota: Comuníquese con su compañía de cable para la disponibilidad del módulo DCM. Este módulo le permite sintonizar canales digitales y de alta definición (donde estén disponibles) a través de su antena del cable. También podrá ser posible ordenar programas de pago por evento.

Lock (Bloqueo)

Este televisor de proyección HDTV contiene tecnología V-CHIP para bloquear películas y programas de televisión de acuerdo a su clasificación. Existen dos (2) Clasificaciones de Contenido: MPAA (Motion Picture Association of America) y Guía de Clasificaciones para TV de los EEUU. Estas clasificaciones son usadas como guías para bloquear los programas. El modo default para el bloqueo es Unlocked (desbloqueado). En este modo, usted puede ver varias categorías del menú Lock. Después de crear una contraseña, esta le será requerida antes de hacer cualquier cambio en el menú Lock.

Creando una contraseña

Una contraseña es creada usando el menú New Password.



Procedimiento

- Presione el botón **MENU** para desplegar el menú principal.
- Use los botones de navegación para seleccionar el icono de LOCK.
- Presione **OK** para mostrar la pantalla Create Password.
- Use el teclado numérico para introducir su código de cuatro dígitos. (Use un código fácil de recordar, y escríbalo en un lugar seguro.)
- Presione **OK** para salvar el código. Ahora el televisor esta bloqueado.

Lock Set (Bloquear el televisor)

- Mode** - Para prevenir juegos de video y videocasetes de ser vistos. Las opciones posibles son:
 - Off - Para apagar la función de bloqueo.
 - All (Todos) - All channels are locked regardless of the rating level.
 - Game Lock - Para bloquear las canales 3, 4 y las entradas de video.
 - Channel Lock - Bloquea canales análogos y digitales específicos. La contraseña es requerida para ver cualquiera de los canales bloqueados.

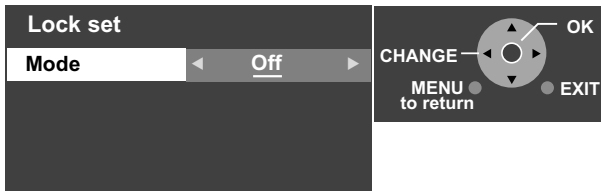

Procedimiento

- Estando en el menú de Lock, seleccione Lock Set y presione **OK** para mostrar el sub-menú.
- Presione **◀ VOL** o **VOL ▶** para seleccionar la opción deseada y presione **OK**.
- Presione **MENU** para regresar a la pantalla anterior.

Channel Lock (Bloqueo de canales)

Esta opción le permite seleccionar la señal de entrada por RF (Antenna (A) o Antenna (B)) y bloquear hasta cuatro (4) canales por cada una. La contraseña es requerida para ver estos canales.

- RF Input** - Seleccione Antenna (A) o Antenna (B).
- Channel** - Seleccione hasta cuatro (4) canales para que sean bloqueados. Estos canales serán bloqueados independientemente de su clasificación.

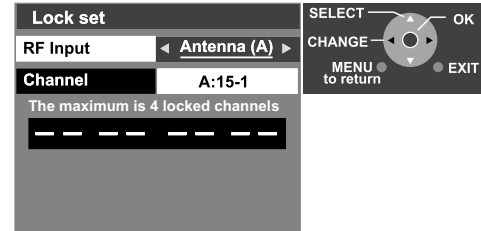

Procedimiento

- En Lock Set, seleccione Channel Lock y presione **OK**.
- Presione **MENU** para regresar al menú previo.
- Seleccione Channel Lock y presione **OK** para mostrar el sub-menú Channel Lock.
- Presione **OK** y seleccione Antenna (A) or Antenna (B) usando **◀ VOL** o **VOL ▶**.
- Presione **CH ▼** y luego **OK**.
- Seleccione los canales que desea bloquear usando los botones de navegación y presione **OK**. Un máximo de cuatro (4) canales pueden ser bloqueados por entrada. Estos canales serán bloqueados independientemente de su clasificación.

Nota: Para quitar el canal de la lista, seleccione el mismo canal y presione **OK**.

Block Program (Bloquear programa)

Esta función le permite bloquear películas y programas de televisión basado en el sistema de clasificación de la MPAA y de TV de los EEUU.

- MPAA** - La MPAA usa las clasificaciones estándar usadas en las películas para prevenir que estas se vean.

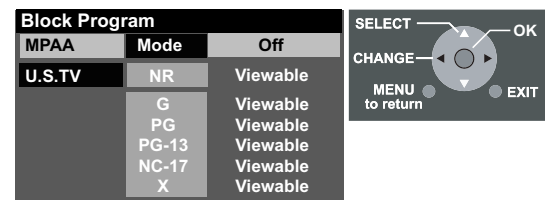

Procedimiento

- En el menú Lock, seleccione Block Program y presione **OK** para entrar al sub-menú.
- Presione **OK** para entrar al campo y seleccione Off o On usando **◀ VOL** o **VOL ▶**. Presione **OK** para guardar su elección.
- Presione los botones **CH ▼▲** para seleccionar el nivel de clasificación deseado.
- Presione **OK** para cambiar el limite a "Viewable" o "Blocked".

Nota: La clasificación NR es independiente de las demás clasificaciones. Al colocar un bloqueo a una clasificación específica, bloqueará esta clasificación y todas las de menor restricción que ella.

Para las conocer la descripción de las clasificaciones de la MPA, favor de ver la siguiente tabla.

Tabla de Clasificación de MPA

NR	PROGRAMA NO CLASIFICADO..
G	AUDIENCIA GENERAL. Se admiten todas las edades.
PG	GUIA DE LOS PADRES SUGERIDA. Con material no aconsejable para niños.
PG-13	FUERTE SUPERVISION DE LOS PADRES. Con material que puede ser inapropiado para niños menores de 13 años.
R	RESTRINGIDO. Menores de 17 años necesitan ir acompañados de uno de los padres ó un adulto.
NC-17	NO SE ADMITE A NADIE DE 17 AÑOS O MENOS.
X	SOLO ADULTOS.

U.S. TV Rating (Clasificación de TV de EEUU)

Esta guía tiene 7 niveles de clasificaciones basadas en edades que pueden ser elegidas. Estos 7 niveles están divididos en 2 grupos según la edad: clasificaciones basadas en juventud (Youth) y clasificaciones basadas en orientación (Guidance). Algunas de estas clasificaciones por edad también tienen clasificaciones por contenido, denominadas como D (Diálogo), L (Lenguaje), S (Sexo) y V (Violencia). En la siguiente tabla se muestra la selección de clasificaciones basadas en edad.

Tabla de Clasificación de Programas de EEUU

Grupo basado en edad	Clasificación basada en edad	Posibles selecciones de contenido
NR (Sin clasificación)	TV-NR	<ul style="list-style-type: none"> Viewable (Visible) Blocked (Bloqueado)
Youth	TV - Y	<ul style="list-style-type: none"> Viewable (Visible) Blocked (Bloqueado)
	TV - Y7	<ul style="list-style-type: none"> FV (Violencia Fantásica) Viewable (Visible) Blocked (Bloqueado)
Guidance	TV - G	<ul style="list-style-type: none"> Viewable (Visible) Blocked (Bloqueado)
	TV - PG	<ul style="list-style-type: none"> D,L,S,V (Todas seleccionadas) Cualquier combinación de D, L, S, V
	TV - 14	<ul style="list-style-type: none"> D, L, S, V (Todas seleccionadas) Cualquier combinación de D, L, S, V
	TV - MA	<ul style="list-style-type: none"> L, S, V (Todas seleccionadas) Cualquier combinación de L, S, V

Procedimiento

- En el menú de Block Program, seleccione U.S. TV y presione **OK** para acceder al campo.

- Presione **OK** para seleccionar Off o On y presione **OK**.
- Seleccione la clasificación deseada usando **CH** ▼ o **CH** ▲.
- Presione **OK** para elegir "Viewable" (VERDE) o "Blocked" (ROJO)..

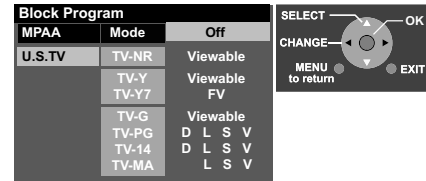

Notas:

- Las clasificaciones como TV-PG, TV-14 y TV-MA también tienen clasificaciones por contenido. Estas clasificaciones pueden ser bloqueadas individualmente. Seleccione la clasificación, presione **VOL** ► para elegir el nivel de contenido y presione **OK** para bloquear.
- La clasificación TV-NR es independiente de las otras clasificaciones.
- Si TV-Y está bloqueada, tanto TV-Y como TV-Y7 serán bloqueadas. Sin embargo, si selecciona TV-Y7, la clasificación FV puede ser bloqueada o desbloqueada.

Tabla De Programas De EEUU

NR	No clasificado. VEA CUIDADO DEL CLIENTE en la página anterior.
TV-Y	Todos los niños. Los temas y elementos en este programa están especialmente diseñados para un público infantil, incluyendo niños de 2-6 años.
TV-Y7	Dirigido a niños mayores. Los temas y elementos en este programa pueden incluir ligera violencia física o cómica, o puede asustar a niños menores de 7 años.
TV-G	Audiencia General. Contiene poca o nada de violencia, nada de lenguaje fuerte, y poco o nada de diálogo o situaciones con contenido sexual.
TV-PG	Guía de los padres sugerida. El programa puede contener lenguaje obscuro infrecuente, violencia limitada, diálogos o situaciones sexualmente sugestivas.
TV-14	Advertencia a los padres. Este programa puede contener temas sofisticados, contenido sexual, lenguaje inapropiado, y violencia más intensa.
TV-MA	Sólo audiencia Madura. Este programa puede contener temas para adultos, lenguaje profano, violencia gráfica y contenido sexual explícito.
FV	FANTASIA/ CARICATURAS CON VIOLENCIA
V	VIOLENCIA
S	SEXO
L	LENGUAJE OFENSIVO
D	DIALOGO CON CONTENIDO SEXUAL

How Long? (¿Cuanto tiempo?)

Esta función le permite bloquear las entradas de señal por un periodo específico de tiempo. Los tiempos disponibles son: 12 horas, 24 horas, 48 horas o Siempre (Always).

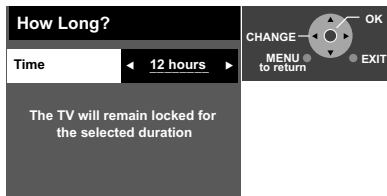

Nota: Si "Always" ha sido seleccionado, y olvida su código secreto, la TV debe ser atendida por un técnico calificado para borrar el ajuste de Bloqueo.

Password (Código secreto)

En esta pantalla puede cambiar su código secreto. Ingrese un código nuevo de cuatro dígitos usando el teclado numérico y este se convertirá en su nuevo código secreto.

Mensajes de Bloqueo

Varios mensajes de bloqueo son desplegados en pantalla dependiendo de la opción seleccionada en el menú LOCK.

Cuando Game Lock es seleccionado

El siguiente mensaje es desplegado cuando se intenta seleccionar entradas de video..

Video Inputs Locked.

Cuando Channel Lock es seleccionado

El siguiente mensaje es desplegado cuando se intenta sintonizar algún canal bloqueado en el menú Channel Lock.

**Channel Locked.
Press OK to enter password.**

Cuando el nivel de clasificación se exede

Si el Block Program está activado y el programa excede el límite de clasificación ajustado por el usuario, aparecerá el mensaje de bloqueo. Su código secreto le será solicitado para ver el canal bloqueado.

**Rating Limit Exceeded.
Press OK to enter password.**

Nota: Al ingresar el código, invalidará la condición de bloqueo. Sin embargo, las clasificaciones elegidas se mantendrán.

About (Pantalla Sobre)

La pantalla sobre muestra información variada sobre el televisor. Por favor tenga esta información a la mano al llamar al centro de atención a clientes.

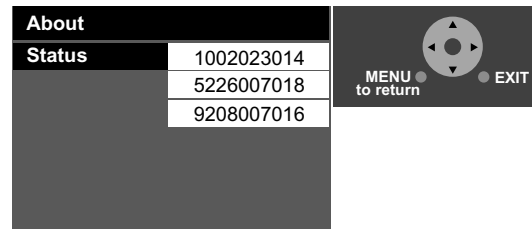

Glosario y Acrónimos

ATSC (Advanced Television System Committee)

Cuerpo regulatorio que desarrolló los formatos terrestres para televisión digital.

DCF (Design Rule for Camera File System)

Estándar unificado establecido por la Asociación de Industrias Electrónicas y de Tecnología de Información de Japón (JEITA).

DCM (Módulo de Cable Digital)

Una tarjeta tipo PCMCIA que es suministrada por el operador de cable.

FAT (File Allocation Table)

FAT 12 o FAT 16: Sistemas de archivo usados para formatear las tarjetas de memoria.

HDMI (High Definition Multimedia Interface)

Interfase que soporta todos los formatos digitales no comprimidos así como todos los formatos de audio multi-canal en un solo cable.

JPEG (Joint Photographic Experts Group)

Sistema usado para comprimir/decodificar imágenes fijas a color.

MPAA (Motion Picture Association of America)

Gremio que gobierna la asignación de clasificaciones de las películas.

NTSC (National Television Systems Committee)

















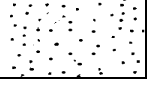

Cuerpo de estandarización que desarrolló los formatos terrestres de televisión analógica.

Password









Un código de cuatro (4) dígitos que el usuario debe proveer para poder llevar a cabo una función.

Cuadro de Localización de Fallas

Antes de solicitar servicio, establezca los síntomas y lleve a cabo las siguientes posibles soluciones

SONIDO	IMAGEN	Soluciones
 Sonido Ruidoso	 Imagen Moteada	Ajuste la Ubicación y/o Conexión de la Antena
 Sonido Normal	 Imagen Múltiple / Corrimiento de color en imagen	Ajuste la Ubicación y la Conexión de la Antena Revise el Cable de Entrada de la Antena Ajuste la convergencia de la imagen (ver págs. 26 y 27)
 Sonido Ruidoso	 Interferencia	Aleje la TV de los Aparatos Electrodomésticos, Luces, Vehículos y Equipo Médico
 Sin Sonido	 Imagen Normal	Aumente el Volúmen Revise Mute (Mudo) Revise en el Menú de Audio: ALTAVOCES > SI (ver págs. 20 y 21) Cambie el Canal
 Sonido Ruidoso	 Sin Imagen/Con Motas	Ajuste apropiadamente la modalidad de TV o del Cable Revise los Cables de la Antena
 Sin Sonido	 Sin Imagen / Sin IDI	Revise que el Cable de Corriente este Enchufado a una toma de Corriente Activa Ajuste los Controles de Brillo y Audio Cambie el Canal Revise las Conexiones del Cable Programa el Control Remoto otra vez Revise la Operación de la Segunda Fuente de Video Señal ATSC débil. Redireccione la antena.
 Sonido Distorsionado	 Digitalización de la imagen Congelamiento de la imagen	Redireccione la antena. Revise la fuerza de la señal (ver página 25). Si la señal es débil, agregue un amplificador de señal para incrementar su fuerza.
 Sonido Normal	 La imagen se recorre ligeramente al encender el receptor, cuando se cambia de canal or dentro de un periodo de 2 horas.	Esta es una condición normal. Esta función puede ser desactivada. Sin embargo, el desactivar esta función puede causar retención en la imagen por lo cual no es recomendado.
 Sonido Normal	 Sin Color	Ajuste el Color Cambie el Canal
 Sonido Erróneo	 Imagen Normal	Revise en el menú de AUDIO que el Ajuste se encuentre en Estéreo o Mono, no en SPA

ESPAÑOL

SONIDO	IMAGEN	Soluciones
 Sonido Normal	 Caja Negra en Pantalla	Cambie CC (Subtítulos) de la Modalidad de Texto a NO
Sonido Normal Operación Intermitente del Control Remoto	Imagen Normal	Reemplace las Pilas del Control Remoto
Cuando la señal HDMI esta conectada		
 Sin Sonido	 Sin Imagen	Asegurese de no conectar la PC a la entrada HDMI. En algunas ocasiones, el televisor no mostrará imagen por la entrada HDMI cuando este conectado a aparatos con salida HDMI o DVI debido a mala comunicación entre el televisor y los aparatos. Si esto sucede, desconecte el aparato HDMI/DVI y vuelvalo a conectar.
 Sonido Erróneo	 Imagen Normal	Si usa la entrada HDMI, cambie el audio del aparato HDMI a PCM Lineal. Revise el ajuste de Audio para HDMI (ver pág. 21). Si hay problema con el audio digital, cambie a audio análogo.
 Sonido Normal	 Imagen Normal	Reemplace las Pilas del Control Remoto
Operación Intermitente del Control Remoto		

Numerales

3D Y/C FILTRO 20

A

Add Fav / Del Fav feature 11

Ajuste del reloj 24

Altos 20

Analog (Analog) 26

Apagado (Sleep) 24

Audio 20

Auto Power On (Autoencendido) 26

Auto Programación 25

Auto Scan (Programa Auto) 4

B

Bajos 20

Balance 20

Basic Operation 22

BBE 20

BBE VIVA 3D 20

Block Program 28

Botões PIP MIN y PIP MAX 10

Botón ASPECT 12

Botón BBE 12

Botón Freeze (IDI y Split) 10

Botón MENU 12

Botón Move 9

Botón PROG 12

Botón RECALL 12

Botón R-TUNE 12

Botón SAP 12

Botón Search 9

Botón TV/VIDEO 9

Botones especiales del control remoto 12

Brillo 20

C

Cable de Suministro de Corriente Alterna 4

Cable Module Info (Información del módulo del Cable) 27

Canales (Channels) 21

Captions 21

Card 23

CC Mode (Modo CC) 26

Channel 21

Channel and Program Tuning 11

Channel Banner 11

Channel Lock 28

Closed Caption (Subtítulos) 26

Códigos de Componentes 16, 18

Códigos para CD Player 18

Códigos para DBS 17

Códigos para Decodificador de Cable 17

Códigos para DVD 17

Códigos para Equipos de Casete 18

Códigos para Grabadoras Personales de Video 18

Códigos para Receptores 18

Códigos para VCR 17

Color 20

Color Natural 20

Colors sub-menu 26

Component connection cables 4

Conexión de Antena 4

Conexión de cable 4

Conexión de Cable / Antena 4

Conexión de entrada HDMI 7

Conexión de la Videocasetera 6

Conexión de salida de audio digital 8

Conexión de Salida del Programa 8

Conexión del Amplificador de Sonido (Analog) 8

Conexión del Decodificador de Televisión Digital (DTV-STB) ó DVD 6

Conexión del módulo del cable 6

Conexiones de Equipo Opcional 6

Convergence 4, 26

Convergence Adj. (Fije Convergencia) 27

Corrección de convergencia en nueve puntos 27

Creating a Password 28

Cronom 1 y Cronom 2 24

Cronometro (Timer) 24

Cuadro de Localización

de Fallas 32, 33

Cuidado y Limpieza 3

D

Day Set 24

Digital 26

E

Especificaciones 3

F

Freeze 20

Vista Frontal y Posterior del Televisor

de Proyección de Alta Definición 5

Función de congelamiento de

imagen principal 10

Funciones especiales del Televisor de

proyección de Alta Definición 11

G

Gabinete y Control Remoto 3

H

How Long? (¿Cuanto tiempo?) 30

I

Image Shift 26

Imagen 20

Información Importante Acerca Del

Uso De Video Juegos 1

Información sobre la Convergencia 1

Information Regarding

memory cards 22

Input Labels (Ponga Titulo) 21

Insertando y removiendo

tarjetas SD o PCMCIA 22

Instalación 4

Interval 23

L

Lock (Bloqueo) 28

Lock Set 28

M

Manual Labels (Manual) 21

Matriz Color 20

Medidor de señal 25

Mensaje de Bloqueo 30

Método de sintonización directa 11

MPAA 28

N

Navegación básica del menú 19

Normal 20

O

Operación de Componentes con el control remoto 14

Operación de DBS 14

Operación de decodificador de Cable 14

Operación de DVD 14

Operación de IDI 9

Operación de IDI y Pantalla de SPLIT Botón 9

Operación de PVR (Grabadoras Personales de Video) 15

Operación de receptor de audio 15

Operación de reproductor

de casetes 15

Operación de SPLIT 9

Operación de una Videocasetera 14

Operación del Control Remoto 13

Operación del Menu 20

P

Panel de Control Frontal 6

Password (Código secreto) 30

Photo Viewer™ - Thumbnail mode 22

Photo Viewer™ Setup Menu 23

Programación Manual 25

Programando El Control Remoto 16

Programación Inicial 4

Programar canales 25

Programming Sin Código 16

R

Reduc de Ruido 20

Registro del Usuario 3

Repeat 23

RF Input 21

RF Input Setup 4

Rotate 23

S

Sequence 23

Set Up (AJUSTE) 25

Sintonización forzada por el Sistema de Alerta de Emergencia (EAS) 11

Slide Show 23

Sonido IA 20

Surf Mode 21

T

Tabla de Características 3

Tabla de Clasificación de MPAA 29

Tabla de Clasificación de Programas de EEUU 29

Tabla operacional de los botones en modo IDI ó SPLIT 10

Temp Color 20

TINT 20

Tuning digital and analog channels 11

U

U.S. TV Rating 29

Ubicación de la Televisión 4

V

Velocidad de modulación 20

Z

Zoom 23

Zoom Adjust (Magnificación) 26

PANASONIC CONSUMER ELECTRONICS COMPANY,
DIVISION OF
MATSUSHITA ELECTRIC CORPORATION OF AMERICA
One Panasonic Way
Secaucus, New Jersey 07094

PANASONIC SALES COMPANY,
DIVISION OF
MATSUSHITA ELECTRIC OF PUERTO RICO,
INC., Ave. 65 de Infanteria, Km. 9.5
San Gabriel Industrial Park
Carolina, Puerto Rico 00985

Panasonic Video Projection System Limited Warranty

Limited Warranty Coverage

If your product does not work properly because of a defect in materials or workmanship, Panasonic Consumer Electronics Company or Panasonic Sales Company (collectively referred to as "the warrantor") will, for the length of the period indicated on the chart below, which starts with the date of original purchase ("warranty period"), at its option either (a) repair your product with new or refurbished parts, or (b) replace it with a new or a refurbished product. The decision to repair or replace will be made by the warrantor.

TV CATEGORY	ALL PARTS	LABOR	SERVICE
ALL Projection TV	1 (ONE) YEAR	1 (ONE) YEAR	IN-HOME OR CARRY-IN

During the "Labor" warranty period there will be no charge for labor. During the "Parts" warranty period, there will be no charge for parts. You must carry-in your product or arrange for in-home service during the warranty period. If non-rechargeable batteries are included, they are not warranted. This warranty only applies to products purchased and serviced in the United States or Puerto Rico. This warranty is extended only to the original purchaser of a new product which was not sold "as is". A purchase receipt or other proof of the original purchase date is required for warranty service.

Carry-in or In-Home Service

For In-Home or Carry-In Service in the United States call 1-888-VIEW-PTV (1-888-843-9788).
For assistance in Puerto Rico call Panasonic Sales Company (787)-750-4300 or fax (787)-768-2910.

In-Home service requires clear, complete and easy access to the product by the authorized servicer and does not include removal or re-installation of an installed product. It is possible that certain in-home repairs will not be completed in-home, but will require that the product, or parts of the product, be removed for shop diagnosis and/or repair and then returned.

[Limited Warranty continued on next page](#)

Limited Warranty continued from previous page

Limited Warranty Limits And Exclusions

This warranty ONLY COVERS failures due to defects in materials or workmanship, and DOES NOT COVER normal wear and tear or cosmetic damage, nor does it cover markings or retained images on the picture tube resulting from viewing fixed images (including, among other things, letterbox pictures on standard 4:3 screen TV's, or non-expanded standard 4:3 pictures on wide screen TV's, or onscreen data in a stationary and fixed location). The warranty ALSO DOES NOT COVER damages which occurred in shipment, or failures which are caused by products not supplied by the warrantor, or failures which result from accidents, misuse, abuse, neglect, mishandling, misapplication, alteration, faulty installation, set-up adjustments, misadjustment of consumer controls, improper maintenance, power line surge, lightning damage, modification, or commercial use (such as in a hotel, office, restaurant, or other business), rental use of the product, service by anyone other than a Factory Servicenter or other Authorized Servicer, or damage that is attributable to acts of God.

THERE ARE NO EXPRESS WARRANTIES EXCEPT AS LISTED UNDER "LIMITED WARRANTY COVERAGE". THE WARRANTOR IS NOT LIABLE FOR INCIDENTAL OR CONSEQUENTIAL DAMAGES RESULTING FROM THE USE OF THIS PRODUCT, OR ARISING OUT OF ANY BREACH OF THIS WARRANTY. (As examples, this excludes damages for lost time, cost of having someone remove or re-install an installed unit if applicable, or travel to and from the servicer or loss of images, data or other memory content. The items listed are not exclusive, but are for illustration only.) **ALL EXPRESS AND IMPLIED WARRANTIES, INCLUDING THE WARRANTY OF MERCHANTABILITY, ARE LIMITED TO THE PERIOD OF THE LIMITED WARRANTY.**

Some states do not allow the exclusion or limitation of incidental or consequential damages, or limitations on how long an implied warranty lasts, so the exclusions may not apply to you.

This warranty gives you specific legal rights and you may also have others rights which vary from state to state. If a problem with this product develops during or after the warranty period, you may contact your dealer or Servicenter. If the problem is not handled to your satisfaction, then write to the warrantor's Consumer Affairs Department at the addresses listed for the warrantor.

PARTS AND SERVICE (INCLUDING COST OF AN IN-HOME SERVICE CALL, WHERE APPLICABLE) WHICH ARE NOT COVERED BY THIS LIMITED WARRANTY ARE YOUR RESPONSIBILITY.

***For Product Information, Operating Assistance, Literature Request, Dealer Locations, and all Customer Service inquiries please contact:
1-888-VIEW-PTV (1-888-843-9788, Monday-Friday 9am - 9pm; Saturday-Sunday 10 am - 7pm, EST.***

***Web Site: <http://www.panasonic.com>
You can purchase parts, accessories or locate your nearest servicer by visiting our Web Site.***

Accessory Purchases:

**1-800-332-5368 (Customer Orders Only)
Panasonic Services Company 20421 84th Avenue South, Kent, WA 98032
(6 am to 5 pm Monday - Friday; 6 am to 10:30 am Saturday; PST)
(Visa, MasterCard, Discover Card, American Express, Check)**

***Service in Puerto Rico
Matsushita Electric of Puerto Rico, Inc. Panasonic Sales Company/Factory Servicer:
Ave. 65 de Infantería, Km. 9.5, San Gabriel Industrial Park, Carolina, Puerto Rico 00985
Phone (787) 750-4300 Fax (787) 768-2910***

By using this TV you are indicating acceptance of the GNU Public Licenses indicated below.

This product utilizes the following so called "open source" software:

- (1) the software which is licensed under the GNU GENERAL PUBLIC LICENSE,
- (2) the software which is licensed under the GNU LESSER GENERAL PUBLIC LICENSE, and
- (3) software developed by the third parties and available under certain terms and conditions.

For the software categorized as (1) and (2), please refer to the terms and conditions of the following GNU GENERAL PUBLIC LICENSE and GNU LESSER GENERAL PUBLIC LICENSE respectively.

If you wish to get further information as to the software, please contact the web site below.

<http://www.fsf.org/licenses/> and <http://www.am-linux.jp/>

GNU GENERAL PUBLIC LICENSE

Version 2, June 1991

Copyright (C) 1989, 1991 Free Software Foundation, Inc.
59 Temple Place, Suite 330, Boston, MA 02111-1307, USA

Everyone is permitted to copy and distribute verbatim copies of this license document, but changing it is not allowed.

Preamble

The license for most software are designed to take away your freedom to share and change it. By contrast, the GNU General Public License is intended to guarantee your freedom to share and change free software-to make sure the software is free for all its users. This General Public License applies to most of the Free Software Foundation's software and to any other program whose authors commit to using it. (Some other Free Software Foundation software is covered by the GNU Library General Public License instead.) You can apply it to your programs, too.

When we speak of free software, we are referring to freedom, not price. Our General Public Licenses are designed to make sure that you have the freedom to distribute copies of free software (and charge for this service if you wish), that you receive source code or can get it if you want it, that you can change the software or use pieces of it in new free programs; and that you know you can do these things.

To protect your rights, we need to make restrictions that forbid anyone to deny you these rights or to ask you to surrender the rights. These restrictions translate to certain responsibilities for you if you distribute copies of the software, or if you modify it.

For example, if you distribute copies of such a program, whether gratis or for a fee, you must give the recipients all the rights that you have. You must make sure that they, too, receive or can get the source code. And you must show them these terms so they know their rights.

We protect your rights with two steps: (1) copyright the software, and (2) offer you this license which gives you legal permission to copy, distribute and/or modify the software.

Also, for each author's protection and ours, we want to make certain that everyone understands that there is no warranty for this free software. If the software is modified by someone else and passed on, we want its recipients to know that what they have is not the original, so that any problems introduced by others will not reflect on the original authors' reputations.

Finally, any free program is threatened constantly by software patents. We wish to avoid the danger that redistributors of a free program will individually obtain patent licenses, in effect making the program proprietary. To prevent this, we have made it clear that any patent must be licensed for everyone's free use or not licensed at all. The precise terms and conditions for copying, distribution and modification follow.

TERMS AND CONDITIONS FOR COPYING, DISTRIBUTION AND MODIFICATION

0. This License applies to any program or other work which contains a notice placed by the copyright holder saying it may be distributed under the terms of this General Public License. The "Program", below, refers to any such program or work, and a "work based on the Program" means either the Program or any derivative work under copyright law: that is to say, a work containing the Program or a portion of it, either verbatim or with modifications and/or translated into another language. (Hereinafter, translation is included without limitation in the term "modification".) Each licensee is addressed as "you".

Activities other than copying, distribution and modification are not covered by this License; they are outside its scope. The act of running the Program is not restricted, and the output from the Program is covered only if its contents constitute a work based on the Program (independent of having been made by running the Program). Whether that is true depends on what the Program does.

1. You may copy and distribute verbatim copies of the Program's source code as you receive it, in any medium, provided that you conspicuously and appropriately publish on each copy an appropriate copyright notice and disclaimer of warranty; keep intact all the notices that refer to this License and to the absence of any warranty; and give any other recipients of the Program a copy of this License along with the Program.

You may charge a fee for the physical act of transferring a copy, and you may at your option offer warranty protection in exchange for a fee.

2. You may modify your copy or copies of the Program or any portion of it, thus forming a work based on the Program, and copy and distribute such modifications or work under the terms of Section 1 above, provided that you also meet all of these conditions:

a) You must cause the modified files to carry prominent notices stating that you changed the files and the date of any change.

b) You must cause any work that you distribute or publish, that in whole or in part contains or is derived from the Program or any part thereof, to be licensed as a whole at no charge to all third parties under the terms of this License.

c) If the modified program normally reads commands interactively when run, you must cause it, when started running for such interactive use in the most ordinary way, to print or display an announcement including an appropriate copyright notice and a notice that there is no warranty (or else, saying that you provide a warranty) and that users may redistribute the program under these conditions, and telling the user how to view a copy of this License. (Exception: if the Program itself is interactive but does not normally print such an announcement, your work based on the Program is not required to print an announcement.)

These requirements apply to the modified work as a whole. If identifiable sections of that work are not derived from the Program,

and can be reasonably considered independent and separate works in themselves, then this License, and its terms, do not apply to those sections when you distribute them as separate works. But when you distribute the same sections as part of a whole which is a work based on the Program, the distribution of the whole must be on the terms of this License, whose permissions for other licensees extend to the entire whole, and thus to each and every part regardless of who wrote it.

Thus, it is not the intent of this section to claim rights or contest your rights to work written entirely by you; rather, the intent is to exercise the right to control the distribution of derivative or collective works based on the Program.

In addition, mere aggregation of another work not based on the Program with the Program (or with a work based on the Program) on a volume of a storage or distribution medium does not bring the other work under the scope of this License.

3. You may copy and distribute the Program (or a work based on it, under Section 2) in object code or executable form under the terms of Sections 1 and 2 above provided that you also do one of the following:

- a) Accompany it with the complete corresponding machine-readable source code, which must be distributed under the terms of Sections 1 and 2 above on a medium customarily used for software interchange; or,
- b) Accompany it with a written offer, valid for at least three years, to give any third party, for a charge no more than your cost of physically performing source distribution, a complete machine-readable copy of the corresponding source code, to be distributed under the terms of Sections 1 and 2 above on a medium customarily used for software interchange; or,
- c) Accompany it with the information you received as to the offer to distribute corresponding source code. (This alternative is allowed only for noncommercial distribution and only if you received the program in object code or executable form with such an offer, in accord with Subsection b above.)

The source code for a work means the preferred form of the work for making modifications to it. For an executable work, complete source code means all the source code for all modules it contains, plus any associated interface definition files, plus the scripts used to control compilation and installation of the executable. However, as a special exception, the source code distributed need not include anything that is normally distributed (in either source or binary form) with the major components (compiler, kernel, and so on) of the operating system on which the executable runs, unless that component itself accompanies the executable.

If distribution of executable or object code is made by offering access to copy from a designated place, then offering equivalent access to copy the source code from the same place counts as distribution of the source code, even though third parties are not compelled to copy the source along with the object code.

4. You may not copy, modify, sublicense, or distribute the Program except as expressly provided under this License. Any attempt otherwise to copy, modify, sublicense or distribute the Program is void, and will automatically terminate your rights under this License. However, parties who have received copies, or rights, from you under this License will not have their licenses terminated so long as such parties remain in full compliance.

5. You are not required to accept this License, since you have not signed it. However, nothing else grants you permission to modify or distribute the Program or its derivative works. These actions are prohibited by law if you do not accept this License. Therefore, by modifying or distributing the Program (or any work based on the Program), you indicate your acceptance of this License to do so, and all its terms and conditions for copying, distributing or modifying the Program or works based on it.

6. Each time you redistribute the Program (or any work based on the Program), the recipient automatically receives a license from the original licensor to copy, distribute or modify the Program subject to these terms and conditions. You may not impose any further restrictions on the recipients' exercise of the rights granted herein. You are not responsible for enforcing compliance by third parties to this License.

7. If, as a consequence of a court judgment or allegation of patent infringement or for any other reason (not limited to patent issues), conditions are imposed on you (whether by court order, agreement or otherwise) that contradict the conditions of this License, they do not excuse you from the conditions of this License. If you cannot distribute so as to satisfy simultaneously your obligations under this License and any other pertinent obligations, then as a consequence you may not distribute the Program at all. For example, if a patent license would not permit royalty-free redistribution of the Program by all those who receive copies directly or indirectly through you, then the only way you could satisfy both it and this License would be to refrain entirely from distribution of the Program.

If any portion of this section is held invalid or unenforceable under any particular circumstance, the balance of the section is intended to apply and the section as a whole is intended to apply in other circumstances.

It is not the purpose of this section to induce you to infringe any patents or other property right claims or to contest validity of any such claims; this section has the sole purpose of protecting the integrity of the free software distribution system, which is implemented by public license practices. Many people have made generous contributions to the wide range of software distributed through that system in reliance on consistent application of that system; it is up to the author/donor to decide if he or she is willing to distribute software through any other system and a licensee cannot impose that choice.

This section is intended to make thoroughly clear what is believed to be a consequence of the rest of this License.

8. If the distribution and/or use of the Program is restricted in certain countries either by patents or by copyrighted interfaces, the original copyright holder who places the Program under this License may add an explicit geographical distribution limitation excluding those countries, so that distribution is permitted only in or among countries not thus excluded. In such case, this License incorporates the limitation as if written in the body of this License.

9. The Free Software Foundation may publish revised and/or new versions of the General Public License from time to time. Such new versions will be similar in spirit to the present version, but may differ in detail to address new problems or concerns.

Each version is given a distinguishing version number. If the Program specifies a version number of this License which applies to it and "any later version", you have the option of following the terms and conditions either of that version or of any later version published by the Free

Software Foundation. If the Program does not specify a version number of this License, you may choose any version ever published by the Free Software Foundation.

10. If you wish to incorporate parts of the Program into other free programs whose distribution conditions are different, write to the author to ask for permission. For software which is copyrighted by the Free Software Foundation, write to the Free Software Foundation; we sometimes make exceptions for this. Our decision will be guided by the two goals of preserving the free status of all derivatives of our free software and of promoting the sharing and reuse of software generally.

NO WARRANTY

11. BECAUSE THE PROGRAM IS LICENSED FREE OF CHARGE, THERE IS NO WARRANTY FOR THE PROGRAM, TO THE EXTENT PERMITTED BY APPLICABLE LAW. EXCEPT WHEN OTHERWISE STATED IN WRITING THE COPYRIGHT HOLDERS AND/OR OTHER PARTIES PROVIDE THE PROGRAM "AS IS" WITHOUT WARRANTY OF ANY KIND, EITHER EXPRESSED OR IMPLIED, INCLUDING, BUT NOT LIMITED TO, THE IMPLIED WARRANTIES OF MERCHANTABILITY AND FITNESS FOR A PARTICULAR PURPOSE. THE ENTIRE RISK AS TO THE QUALITY AND PERFORMANCE OF THE PROGRAM IS WITH YOU. SHOULD THE PROGRAM PROVE DEFECTIVE, YOU ASSUME THE COST OF ALL NECESSARY SERVICING, REPAIR OR CORRECTION.

12. IN NO EVENT UNLESS REQUIRED BY APPLICABLE LAW OR AGREED TO IN WRITING WILL ANY COPYRIGHT HOLDER, OR ANY OTHER PARTY WHO MAY MODIFY AND/OR REDISTRIBUTE THE PROGRAM AS PERMITTED ABOVE, BE LIABLE TO YOU FOR DAMAGES, INCLUDING ANY GENERAL, SPECIAL, INCIDENTAL OR CONSEQUENTIAL DAMAGES ARISING OUT OF THE USE OR INABILITY TO USE THE PROGRAM (INCLUDING BUT NOT LIMITED TO LOSS OF DATA OR DATA BEING RENDERED INACCURATE OR LOSSES SUSTAINED BY YOU OR THIRD PARTIES OR A FAILURE OF THE PROGRAM TO OPERATE WITH ANY OTHER PROGRAMS), EVEN IF SUCH HOLDER OR OTHER PARTY HAS BEEN ADVISED OF THE POSSIBILITY OF SUCH DAMAGES.

END OF TERMS AND CONDITIONS

How to Apply These Terms to Your New Programs

If you develop a new program, and you want it to be of the greatest possible use to the public, the best way to achieve this is to make it free software which everyone can redistribute and change under these terms.

To do so, attach the following notices to the program. It is safest to attach them to the start of each source file to most effectively convey the exclusion of warranty; and each file should have at least the "copyright" line and a pointer to where the full notice is found.

<One line to give the program's name and an idea of what it does.>
Copyright (C) <year> <name of author>

This program is free software; you can redistribute it and/or modify it under the terms of the GNU General Public License as published by the Free Software Foundation; either version 2 of the License, or (at your option) any later version.

This program is distributed in the hope that it will be useful, but WITHOUT ANY WARRANTY; without even the implied warranty of MERCHANTABILITY or FITNESS FOR A PARTICULAR PURPOSE. See the GNU General Public License for more details.

You should have received a copy of the GNU General Public License along with this program; if not, write to the Free Software Foundation, Inc., 59 Temple Place - Suite 330, Boston, MA 02111-1307, USA

Also add information on how to contact you by electronic and paper mail. If the program is interactive, make it output a short notice like this when it starts in an interactive mode:

Gnomovision version 69, Copyright (C) year name of author
Gnomovision comes with ABSOLUTELY NO WARRANTY; for details type show w'.

This is free software, and you are welcome to redistribute it under certain conditions; type `show c' for details.

The hypothetical commands `show w' and `show c' should show the appropriate parts of the General Public License. Of course, the commands you use may be called something other than `show w' and `show c'; they could even be mouse-clicks or menu items--whatever suits your program.

You should also get your employer (if you work as a programmer) or your school, if any, to sign a "copyright disclaimer" for the program, if necessary. Here is a sample; alter the names:

Yoyodyne, Inc., hereby disclaims all copyright interest in the program `Gnomovision' (which makes passes at compilers) written by James Hacker.

<signature of Ty Coon>, 1 April 1989

Ty Coon, President of Vice

This General Public License does not permit incorporating your program into proprietary programs. If your program is a subroutine library, you may consider it more useful to permit linking proprietary applications with the library. If this is what you want to do, use the GNU Library General Public License instead of this License.

GNU LESSER GENERAL PUBLIC LICENSE

Version 2.1, February 1999

Copyright (C) 1991, 1999 Free Software Foundation, Inc.

59 Temple Place, Suite 330, Boston, MA 02111-1307 USA

Everyone is permitted to copy and distribute verbatim copies of this license document, but changing it is not allowed.

[This is the first released version of the Lesser GPL. It also counts as the successor of the GNU Library Public License, version 2, hence the version number 2.1.]

Preamble

The licenses for most software are designed to take away your freedom to share and change it. By contrast, the GNU General Public Licenses are intended to guarantee your freedom to share and change free software--to make sure the software is free for all its users.

This license, the Lesser General Public License, applies to some specially designated software packages--typically libraries--of the Free Software Foundation and other authors who decide to use it. You can use it too, but we suggest you first think carefully about whether this license or the ordinary General Public License is the better strategy to use in any particular case, based on the explanations below.

When we speak of free software, we are referring to freedom of use, not price. Our General Public Licenses are designed to make sure that you have the freedom to distribute copies of free software (and charge for this service if you wish); that you receive source code or can get it if you want it; that you can change the software and use pieces of it in new free programs; and that you are informed that you can do these things.

To protect your rights, we need to make restrictions that forbid distributors to deny you these rights or to ask you to surrender these rights. These restrictions translate to certain responsibilities for you if you distribute copies of the library or if you modify it.

For example, if you distribute copies of the library, whether gratis or for a fee, you must give the recipients all the rights that we gave you. You must make sure that they, too, receive or can get the source code. If you link other code with the library, you must provide complete object files to the recipients, so that they can relink them with the library after making changes to the library and recompiling it. And you must show them these terms so they know their rights.

We protect your rights with a two-step method: (1) we copyright then library, and (2) we offer you this license, which gives you legal permission to copy, distribute and/or modify the library.

To protect each distributor, we want to make it very clear that there is no warranty for the free library. Also, if the library is modified by someone else and passed on, the recipients should know that what they have is not the original version, so that the original author's reputation will not be affected by problems that might be introduced by others.

Finally, software patents pose a constant threat to the existence of any free program. We wish to make sure that a company cannot effectively restrict the users of a free program by obtaining a restrictive license from a patent holder. Therefore, we insist that any patent license obtained for a version of the library must be consistent with the full freedom of use specified in this license.

Most GNU software, including some libraries, is covered by the ordinary GNU General Public License. This license, the GNU Lesser General Public License, applies to certain designated libraries, and is quite different from the ordinary General Public License. We use this license for certain libraries in order to permit linking those libraries into non-free programs.

When a program is linked with a library, whether statically or using a shared library, the combination of the two is legally speaking a combined work, a derivative of the original library. The ordinary General Public License therefore permits such linking only if the entire combination fits its criteria of freedom. The Lesser General Public License permits more lax criteria for linking other code with the library.

We call this license the "Lesser" General Public License because it does Less to protect the user's freedom than the ordinary General Public License. It also provides other free software developers Less of an advantage over competing non-free programs. These disadvantages are the reason we use the ordinary General Public License for many libraries. However, the Lesser license provides advantages in certain special circumstances.

For example, on rare occasions, there may be a special need to encourage the widest possible use of a certain library, so that it becomes a de-facto standard. To achieve this, non-free programs must be allowed to use the library. A more frequent case is that a free library does the same job as widely used non-free libraries. In this case, there is little to gain by limiting the free library to free software only, so we use the Lesser General Public License.

In other cases, permission to use a particular library in non-free programs enables a greater number of people to use a large body of free software. For example, permission to use the GNU C Library in non-free programs enables many more people to use the whole GNU operating system, as well as its variant, the GNU/Linux operating system.

Although the Lesser General Public License is Less protective of the users' freedom, it does ensure that the user of a program that is linked with the Library has the freedom and the wherewithal to run that program using a modified version of the Library.

The precise terms and conditions for copying, distribution and modification follow. Pay close attention to the difference between a "work based on the library" and a "work that uses the library". The former contains code derived from the library, whereas the latter must be combined with the library in order to run.

TERMS AND CONDITIONS FOR COPYING, DISTRIBUTION AND MODIFICATION

0. This License Agreement applies to any software library or other program which contains a notice placed by the copyright holder or other authorized party saying it may be distributed under the terms of this Lesser General Public License (also called "this License"). Each licensee is addressed as "you".

A "library" means a collection of software functions and/or data prepared so as to be conveniently linked with application programs (which use some of those functions and data) to form executables.

The "Library", below, refers to any such software library or work which has

been distributed under these terms. A "work based on the Library" means either the Library or any derivative work under copyright law: that is to say, a work containing the Library or a portion of it, either verbatim or with modifications and/or translated straightforwardly into another language. (Hereinafter, translation is included without limitation in the term "modification".)

"Source code" for a work means the preferred form of the work for making modifications to it. For a library, complete source code means all the source code for all modules it contains, plus any associated interface definition files, plus the scripts used to control compilation and installation of the library.

Activities other than copying, distribution and modification are not covered by this License; they are outside its scope. The act of running a program using the Library is not restricted, and output from such a program is covered only if its contents constitute a work based on the Library (independent of the use of the Library in a tool for writing it). Whether that is true depends on what the Library does and what the program that uses the Library does.

1. You may copy and distribute verbatim copies of the Library's complete source code as you receive it, in any medium, provided that you conspicuously and appropriately publish on each copy an appropriate copyright notice and disclaimer of warranty; keep intact all the notices that refer to this License and to the absence of any warranty; and distribute a copy of this License along with the Library.

You may charge a fee for the physical act of transferring a copy, and you may at your option offer warranty protection in exchange for a fee.

2. You may modify your copy or copies of the Library or any portion of it, thus forming a work based on the Library, and copy and distribute such modifications or work under the terms of Section 1 above, provided that you also meet all of these conditions:

- a) The modified work must itself be a software library.
- b) You must cause the files modified to carry prominent notices stating that you changed the files and the date of any change.
- c) You must cause the whole of the work to be licensed at no charge to all third parties under the terms of this License.
- d) If a facility in the modified Library refers to a function or a table of data to be supplied by an application program that uses the facility, other than as an argument passed when the facility is invoked, then you must make a good faith effort to ensure that, in the event an application does not supply such function or table, the facility still operates, and performs whatever part of its purpose remains meaningful.

(For example, a function in a library to compute square roots has a purpose that is entirely well-defined independent of the application. Therefore, Subsection 2d requires that any application-supplied function or table used by this function must be optional: if the application does not supply it, the square root function must still compute square roots.)

These requirements apply to the modified work as a whole. If identifiable sections of that work are not derived from the Library, and can be reasonably considered independent and separate works in themselves, then this License, and its terms, do not apply to those sections when you distribute them as separate works. But when you distribute the same sections as part of a whole which is a work based on the Library, the distribution of the whole must be on the terms of this License, whose permissions for other licensees extend to the entire whole, and thus to each and every part regardless of who wrote it.

Thus, it is not the intent of this section to claim rights or contest your rights to work written entirely by you; rather, the intent is to exercise the right to control the distribution of derivative or collective works based on the Library.

In addition, mere aggregation of another work not based on the Library with the Library (or with a work based on the Library) on a volume of a storage or distribution medium does not bring the other work under the scope of this License.

3. You may opt to apply the terms of the ordinary GNU General Public License instead of this License to a given copy of the Library. To do this, you must alter all the notices that refer to this License, so that they refer to the ordinary GNU General Public License, version 2, instead of to this License. (If a newer version than version 2 of the ordinary GNU General Public License has appeared, then you can specify that version instead if you wish.) Do not make any other change in these notices.

Once this change is made in a given copy, it is irreversible for that copy, so the ordinary GNU General Public License applies to all subsequent copies and derivative works made from that copy.

This option is useful when you wish to copy part of the code of the Library into a program that is not a library.

4. You may copy and distribute the Library (or a portion or derivative of it, under Section 2) in object code or executable form under the terms of Sections 1 and 2 above provided that you accompany it with the complete corresponding machine-readable source code, which must be distributed under the terms of Sections 1 and 2 above on a medium customarily used for software interchange.

If distribution of object code is made by offering access to copy from a designated place, then offering equivalent access to copy the source code from the same place satisfies the requirement to distribute the source code, even though third parties are not compelled to copy the source along with the object code.

5. A program that contains no derivative of any portion of the Library, but is designed to work with the Library by being compiled or linked with it, is called a "work that uses the Library". Such a work, in isolation, is not a derivative work of the Library, and therefore falls outside the scope of this License.

However, linking a "work that uses the Library" with the Library creates an executable that is a derivative of the Library (because it contains portions of the Library), rather than a "work that uses the library". The executable is therefore covered by this License. Section 6 states terms for distribution of such executables.

When a "work that uses the Library" uses material from a header file that is part of the Library, the object code for the work may be a derivative work of the Library even though the source code is not. Whether this is true is especially significant if the work can be linked without the Library, or if the work is itself a library. The threshold for this to be true is not precisely defined by law.

If such an object file uses only numerical parameters, data structure layouts and accessors, and small macros and small inline functions (ten lines or less in length), then the use of the object file is unrestricted, regardless of whether it is legally a derivative work. (Executables containing this object code plus portions of the Library will still fall under Section 6.)

Otherwise, if the work is a derivative of the Library, you may distribute the object code for the work under the terms of Section 6. Any executables

containing that work also fall under Section 6, whether or not they are linked directly with the Library itself.

6. As an exception to the Sections above, you may also combine or link a "work that uses the Library" with the Library to produce a work containing portions of the Library, and distribute that work under terms of your choice, provided that the terms permit modification of the work for the customer's own use and reverse engineering for debugging such modifications.

You must give prominent notice with each copy of the work that the Library is used in it and that the Library and its use are covered by this License. You must supply a copy of this License. If the work during execution displays copyright notices, you must include the copyright notice for the Library among them, as well as a reference directing the user to the copy of this License. Also, you must do one of these things:

a) Accompany the work with the complete corresponding machine-readable source code for the Library including whatever changes were used in the work (which must be distributed under Sections 1 and 2 above); and, if the work is an executable linked with the Library, with the complete machine-readable "work that uses the Library", as object code and/or source code, so that the user can modify the Library and then relink to produce a modified executable containing the modified Library. (It is understood that the user who changes the contents of definitions files in the Library will not necessarily be able to recompile the application to use the modified definitions.)

b) Use a suitable shared library mechanism for linking with the Library. A suitable mechanism is one that (1) uses at run time a copy of the library already present on the user's computer system, rather than copying library functions into the executable, and (2) will operate properly with a modified version of the library, if the user installs one, as long as the modified version is interface-compatible with the version that the work was made with.

c) Accompany the work with a written offer, valid for at least three years, to give the same user the materials specified in Subsection 6a, above, for a charge no more than the cost of performing this distribution.

d) If distribution of the work is made by offering access to copy from a designated place, offer equivalent access to copy the above specified materials from the same place.

e) Verify that the user has already received a copy of these materials or that you have already sent this user a copy.

For an executable, the required form of the "work that uses the Library" must include any data and utility programs needed for reproducing the executable from it. However, as a special exception, the materials to be distributed need not include anything that is normally distributed (in either source or binary form) with the major components (compiler, kernel, and so on) of the operating system on which the executable runs, unless that component itself accompanies the executable.

It may happen that this requirement contradicts the license restrictions of other proprietary libraries that do not normally accompany the operating system. Such a contradiction means you cannot use both them and the Library together in an executable that you distribute.

7. You may place library facilities that are a work based on the Library side-by-side in a single library together with other library facilities not covered by this License, and distribute such a combined library, provided that the separate distribution of the work based on the Library and of the other library facilities is otherwise permitted, and provided that you do these two things:

a) Accompany the combined library with a copy of the same work based on the Library, uncombined with any other library facilities. This must be distributed under the terms of the Sections above.

b) Give prominent notice with the combined library of the fact that part of it is a work based on the Library, and explaining where to find the accompanying uncombined form of the same work.

8. You may not copy, modify, sublicense, link with, or distribute the Library except as expressly provided under this License. Any attempt otherwise to copy, modify, sublicense, link with, or distribute the Library is void, and will automatically terminate your rights under this License. However, parties who have received copies, or rights, from you under this License will not have their licenses terminated so long as such parties remain in full compliance.

9. You are not required to accept this License, since you have not signed it. However, nothing else grants you permission to modify or distribute the Library or its derivative works. These actions are prohibited by law if you do not accept this License. Therefore, by modifying or distributing the Library (or any work based on the Library), you indicate your acceptance of this License to do so, and all its terms and conditions for copying, distributing or modifying the Library or works based on it.

10. Each time you redistribute the Library (or any work based on the Library), the recipient automatically receives a license from the original licensor to copy, distribute, link with or modify the Library subject to these terms and conditions. You may not impose any further restrictions on the recipients' exercise of the rights granted herein. You are not responsible for enforcing compliance by third parties with this License.

11. If, as a consequence of a court judgment or allegation of patent infringement or for any other reason (not limited to patent issues), conditions are imposed on you (whether by court order, agreement or otherwise) that contradict the conditions of this License, they do not excuse you from the conditions of this License. If you cannot distribute so as to satisfy simultaneously your obligations under this License and any other pertinent obligations, then as a consequence you may not distribute the Library at all. For example, if a patent license would not permit royalty-free redistribution of the Library by all those who receive copies directly or indirectly through you, then the only way you could satisfy both it and this License would be to refrain entirely from distribution of the Library.

If any portion of this section is held invalid or unenforceable under any particular circumstance, the balance of the section is intended to apply, and the section as a whole is intended to apply in other circumstances.

It is not the purpose of this section to induce you to infringe any patents or other property right claims or to contest validity of any such claims; this section has the sole purpose of protecting the integrity of the free software distribution system which is implemented by public license practices. Many people have made generous contributions to the wide range of software distributed through that system in reliance on consistent application of that system; it is up to the author/donor to decide if he or she is willing to distribute software through any other system and a licensee cannot impose that choice.

This section is intended to make thoroughly clear what is believed to be a consequence of the rest of this License.

12. If the distribution and/or use of the Library is restricted in certain countries either by patents or by copyrighted interfaces, the original copyright holder who places the Library under this License may add an explicit geographical distribution limitation excluding those countries, so that distribution is permitted only in or among countries not thus excluded. In such case, this License incorporates the limitation as if written in the body of this License.

13. The Free Software Foundation may publish revised and/or new versions of the Lesser General Public License from time to time. Such new versions will be similar in spirit to the present version, but may differ in detail to address new problems or concerns.

Each version is given a distinguishing version number. If the Library specifies a version number of this License which applies to it and "any later version", you have the option of following the terms and conditions either of that version or of any later version published by the Free Software Foundation. If the Library does not specify a license version number, you may choose any version ever published by the Free Software Foundation.

14. If you wish to incorporate parts of the Library into other free programs whose distribution conditions are incompatible with these, write to the author to ask for permission. For software which is copyrighted by the Free Software Foundation, write to the Free Software Foundation; we sometimes make exceptions for this. Our decision will be guided by the two goals of preserving the free status of all derivatives of our free software and of promoting the sharing and reuse of software generally.

NO WARRANTY

15. BECAUSE THE LIBRARY IS LICENSED FREE OF CHARGE, THERE IS NOWARRANTY FOR THE LIBRARY, TO THE EXTENT PERMITTED BY APPLICABLE LAW, EXCEPT WHEN OTHERWISE STATED IN WRITING THE COPYRIGHT HOLDERS AND/OR OTHER PARTIES PROVIDE THE LIBRARY "AS IS" WITHOUT WARRANTY OF ANY KIND, EITHER EXPRESSED OR IMPLIED, INCLUDING, BUT NOT LIMITED TO, THE IMPLIED WARRANTIES OF MERCHANTABILITY AND FITNESS FOR A PARTICULAR PURPOSE. THE ENTIRE RISK AS TO THE QUALITY AND PERFORMANCE OF THE LIBRARY IS WITH YOU. SHOULD THE LIBRARY PROVE DEFECTIVE, YOU ASSUME THE COST OF ALL NECESSARY SERVICING, REPAIR OR CORRECTION.

16. IN NO EVENT UNLESS REQUIRED BY APPLICABLE LAW OR AGREED TO IN WRITING WILL ANY COPYRIGHT HOLDER, OR ANY OTHER PARTY WHO MAY MODIFY AND/OR REDISTRIBUTE THE LIBRARY AS PERMITTED ABOVE, BE LIABLE TO YOU FOR DAMAGES, INCLUDING ANY GENERAL, SPECIAL, INCIDENTAL OR CONSEQUENTIAL DAMAGES ARISING OUT OF THE USE OR INABILITY TO USE THE LIBRARY (INCLUDING BUT NOT LIMITED TO LOSS OF DATA OR DATA BEING RENDERED INACCURATE OR LOSSES SUSTAINED BY YOU OR THIRD PARTIES OR A FAILURE OF THE LIBRARY TO OPERATE WITH ANY OTHER SOFTWARE), EVEN IF SUCH HOLDER OR OTHER PARTY HAS BEEN ADVISED OF THE POSSIBILITY OF SUCH DAMAGES.

END OF TERMS AND CONDITIONS

How to Apply These Terms to Your New Libraries

If you develop a new library, and you want it to be of the greatest possible use to the public, we recommend making it free software that everyone can redistribute and change. You can do so by permitting redistribution under these terms (or, alternatively, under the terms of the ordinary General Public License).

To apply these terms, attach the following notices to the library. It is safest to attach them to the start of each source file to most effectively convey the exclusion of warranty; and each file should have at least the "copyright" line and a pointer to where the full notice is found.

<one line to give the library's name and an idea of what it does.>

Copyright (C) <year> <name of author>

This library is free software; you can redistribute it and/or modify it under the terms of the GNU Lesser General Public License as published by the Free Software Foundation; either version 2.1 of the License, or (at your option) any later version.

This library is distributed in the hope that it will be useful, but WITHOUT ANY WARRANTY; without even the implied warranty of MERCHANTABILITY or FITNESS FOR A PARTICULAR PURPOSE. See the GNU Lesser General Public License for more details.

You should have received a copy of the GNU Lesser General Public License along with this library; if not, write to the Free Software Foundation, Inc., 59 Temple Place, Suite 330, Boston, MA 02111-1307 USA

Also add information on how to contact you by electronic and paper mail.

You should also get your employer (if you work as a programmer) or your school, if any, to sign a "copyright disclaimer" for the library, if necessary. Here is a sample; alter the names:

Yoyodyne, Inc., hereby disclaims all copyright interest in the library 'Frob' (a library for tweaking knobs) written by James Random Hacker.

<signature of Ty Coon>, 1 April 1990

Ty Coon, President of Vice

That's all there is to it!

Panasonic Consumer Electronics Company,
Division of Matsushita
Electric Corporation of America
One Panasonic Way
Secaucus, New Jersey 07094
www.panasonic.com

Panasonic Sales Company,
Division of Matsushita Electric
of Puerto Rico Inc. ("PSC")
Ave. 65 de Infantería, Km 9.5
San Gabriel Industrial Park Carolina,
Puerto Rico 00985
Tel. (787) 750-4300
Fax (787) 768-2910